

Semiconductor Sensor Development

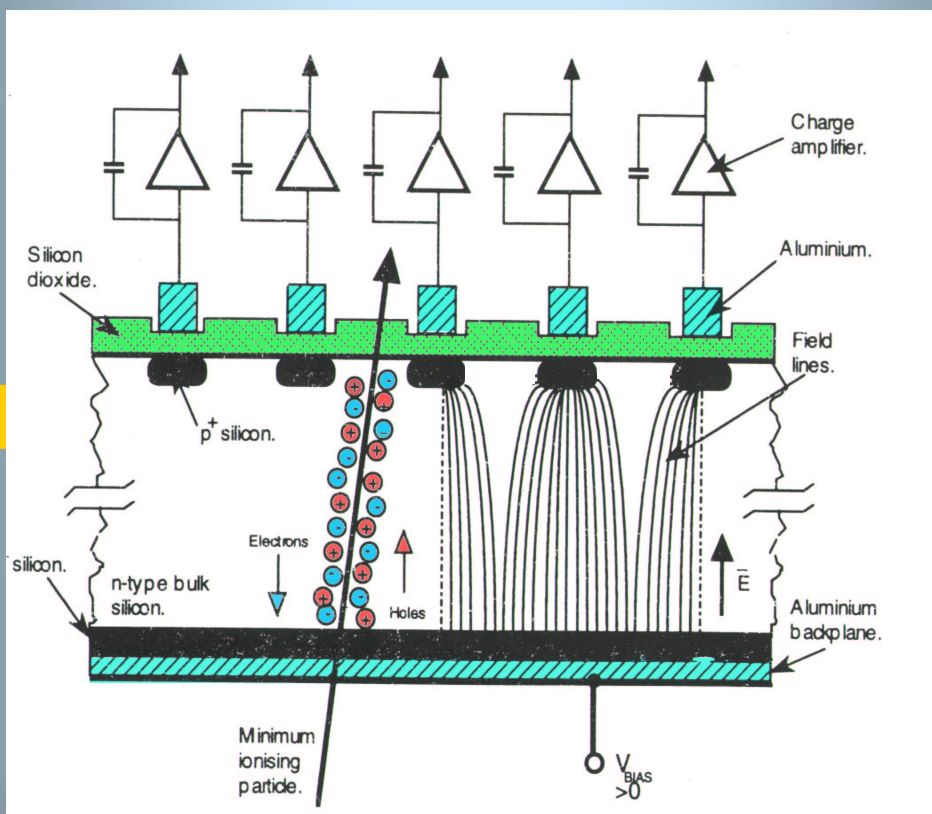

THE UNIVERSITY of LIVERPOOL

Semiconductor sensors are based on segmented diodes which collect the charge produced by photons or ionising radiation.



The position resolution is determined primarily by the granularity; microchip processing technology enables precisions of a few μm to be attained. Applications are numerous, in high energy physics and other fields.

High Radiation Tolerance

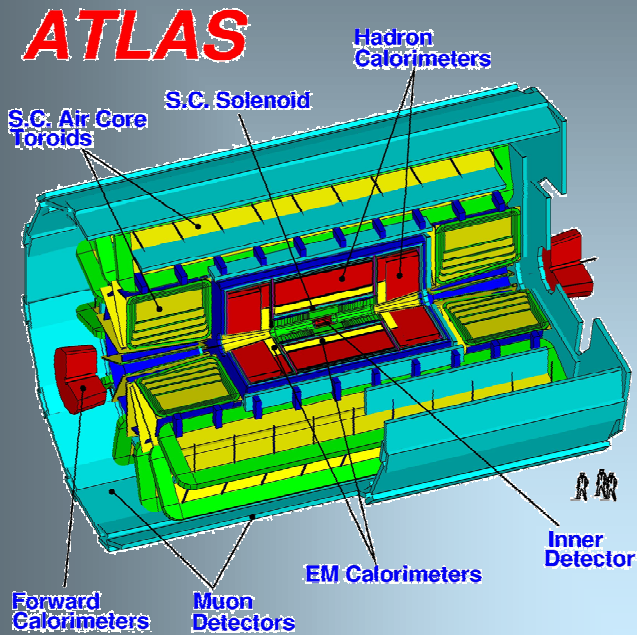

At the LHC, with a billion 14 TeV proton-proton collisions per second, radiation levels can easily exceed 10 MRad. Better modelling of signal generation in radiation damaged silicon at Liverpool has shown that sensor designs collecting electrons give better efficiency for a given operating voltage than those collecting holes. (Prototypes provided by Micron Semiconductor UK Ltd.)

Signal vs voltage for p-type and n-type sensors irradiated to 10 MRad. p-type detectors collect electrons, unlike the other detectors, so can operate efficiently at lower voltages.

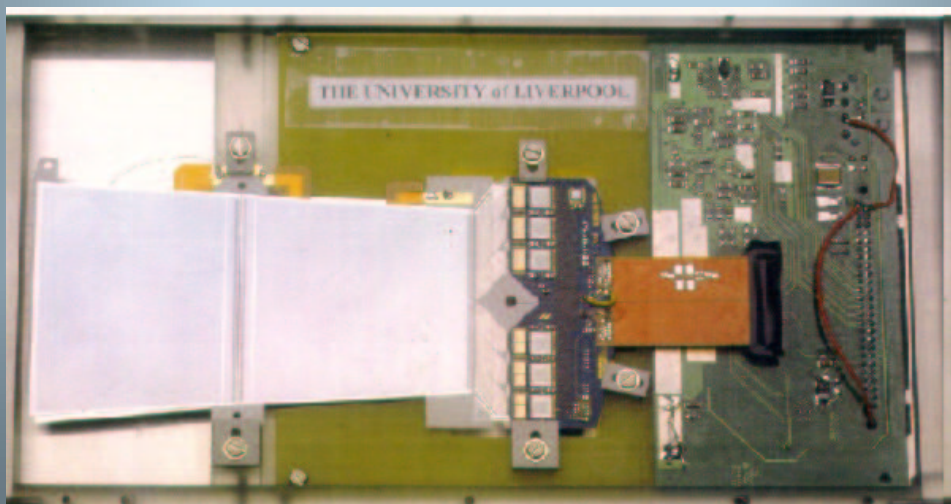
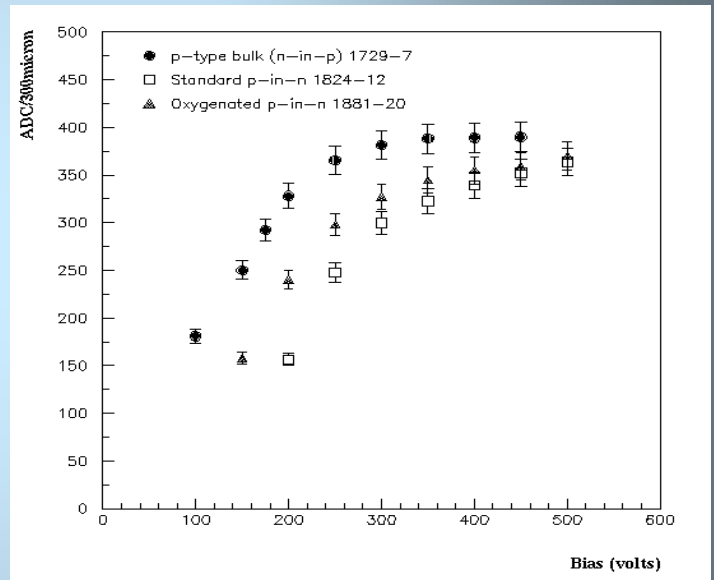

Double sided prototype for the 5000 Silicon Module ATLAS Tracker.

Large Area

NASA's Gamma-ray Large Area Space Telescope Tracker uses 80m² of silicon strip detectors.

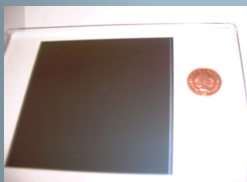
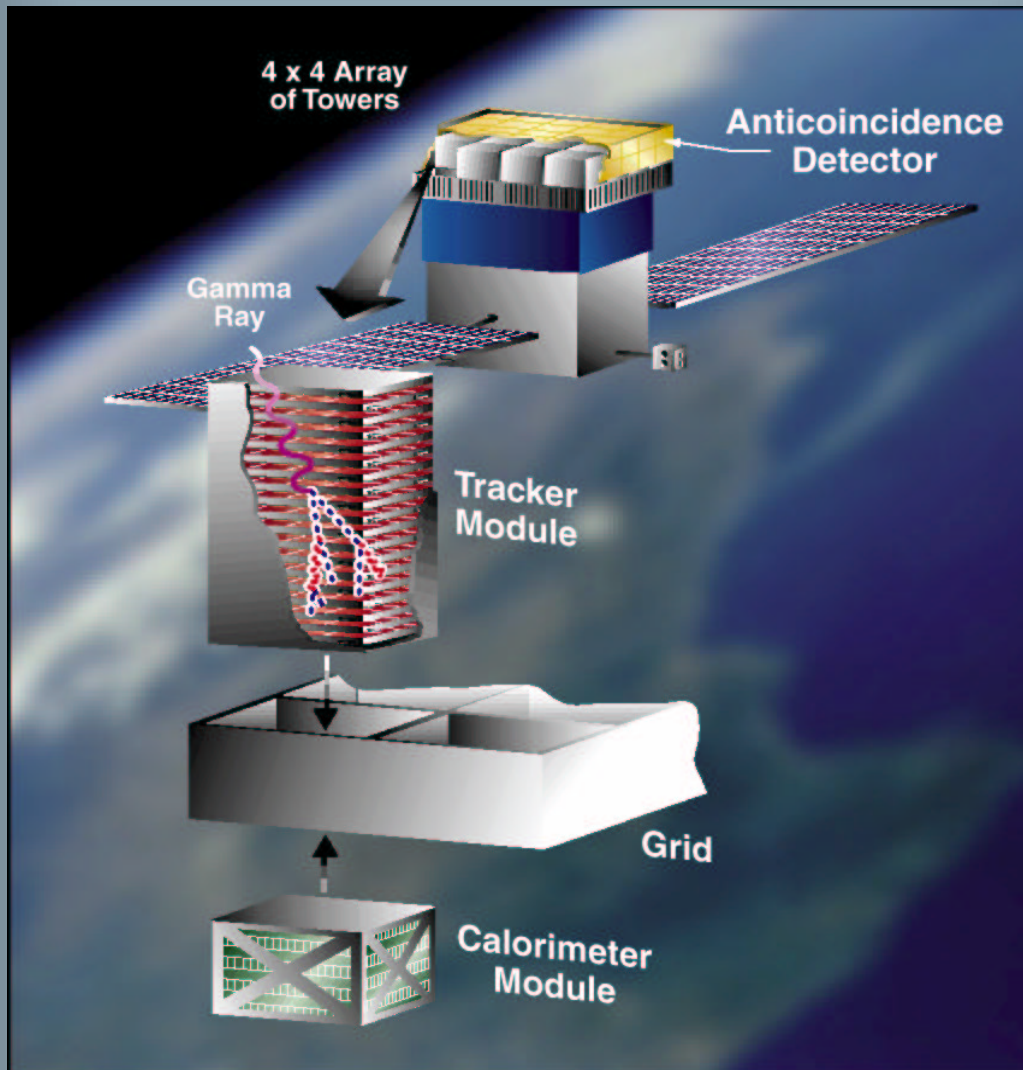

Micron Semiconductor Ltd have fabricated 50 prototype 9cm × 9cm single chip silicon sensors for GLAST using masks designed and purchased by Liverpool.

For areas greater than 1000 m², substrates cheaper than silicon need to be developed. Liverpool is looking at the possibility of using diode strips fabricated on conjugated polymer material.

High Granularity

The 300 Mpixel SLD vertex detector, the most precise yet built, was constructed by RAL and EEV in the UK.

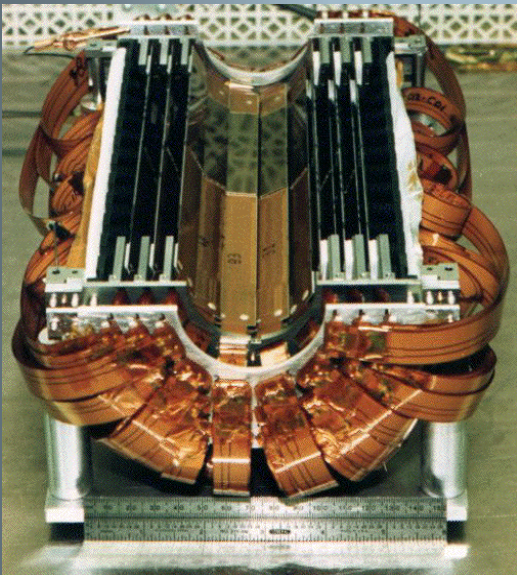

The Linear Collider Flavour Identification collaboration's 800 Mpixel vertex detector for the future linear collider. The CCDs are being developed with Marconi Applied Technologies.

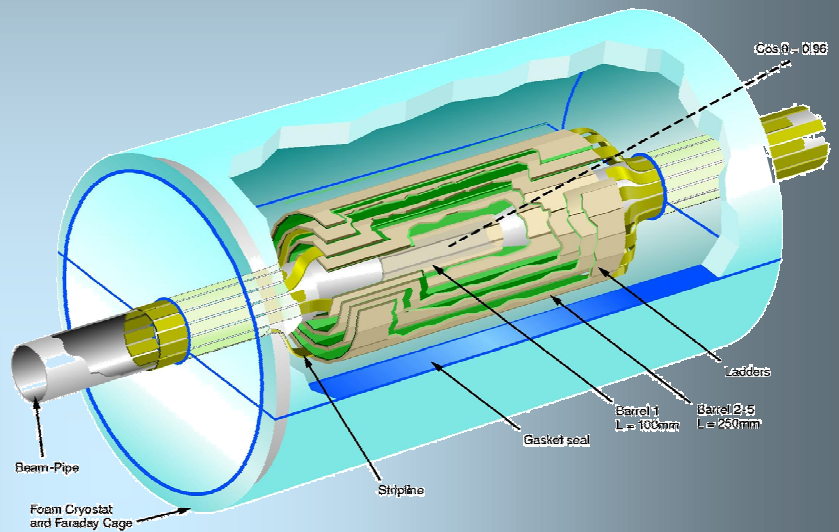

Sensors for the vertex detector of the future linear collider will need to measure to a precision of much better than $5\mu\text{m}$ in two dimensions and be less than $50\mu\text{m}$ thick. CCDs and Monolithic Active Pixel Sensors look to offer the required performance. Both options are being studied at Liverpool.

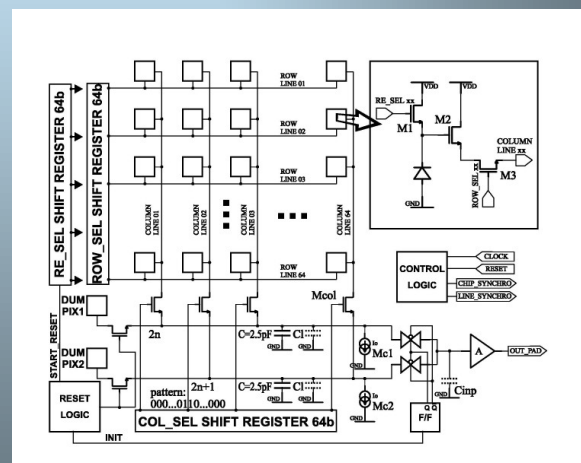
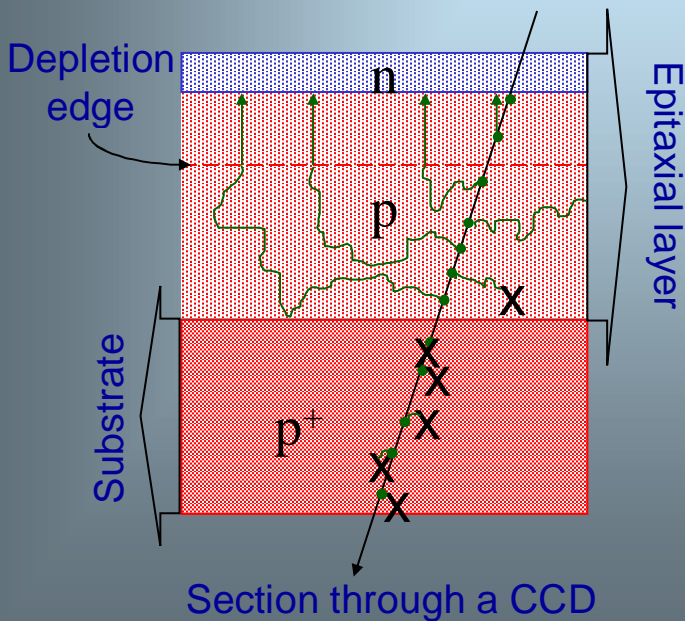

Schematic of MAPS readout

Liverpool Semiconductor Detector Centre



The LSDC, recently built using a £3M JIF grant, consists of 350m² of class 10,000 and 100m² of class 100 clean rooms equipped with state-of-the-art automatic wire bonding (200 connections per cm), probing and large volume co-ordinate measuring machines.

Large arrays of sensors for ATLAS and LHC-b must measure particle tracks with precisions of 10µm and require low mass precision support structures of many m² to ensure the intrinsic resolution of the sensors is not compromised. The LSDC is complemented by a workshop equipped with high precision automatic machine tools to allow Liverpool to construct these detector arrays.

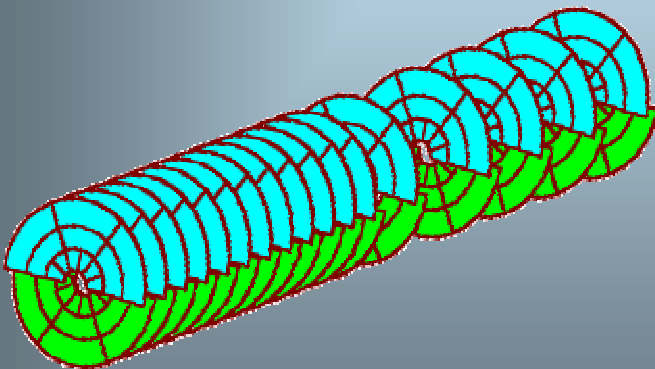

The LHC-b vertex locator, consisting of many layers of double sided, thinned silicon wafers, is one of the major particle physics detectors that will be constructed in the LSDC in the next few years.

LSDC Principal Contractors:

Actiform Group & Kirwin Air Conditioning Ltd (W. Yorkshire)

Cox and Tyre Ltd & J.L. Coldrooms (Merseyside)