

# Large Hadron Electron Collider

Progress Report to ECFA

**DRAFT 25.11.  
20.45 am UK**

Max Klein

for the LHeC Group



CERN Geneva 27. November 2009

[www.lhec.cern.ch](http://www.lhec.cern.ch)



# Electron-Nucleon Scattering at the Tera Scale

CERN-ECFA-NuPECC: Preparing a Conceptual Design Report on the LHeC

The Large Hadron Electron Collider (LHeC) is a new colliding beam facility, based on the LHC at CERN, exploiting Tera scale cms energies in the electron-quark system in order to pursue a rich and luminous programme of inelastic, polarised electron/positron-proton, deuteron and heavy ion scattering measurements. By reaching momentum transfer squared values of  $Q^2$  above  $10^4 \text{ GeV}^2$  and correspondingly low values of Bjorken  $x$ , the LHeC is seen as a natural complement to the LHC and to an envisaged new lepton collider. This poster illustrates part of the still ongoing work on the machine, interaction region and detector designs as well as on the

physics potential of the LHeC at high scales, high parton densities and with high precision eq measurements. This work, pursued in a wide international collaboration under the auspices of CERN, ECFA, NuPECC and a Scientific Advisory Committee, is directed to a Conceptual Design Report by 2010, as part of the deliberations of the HEP community on its future programme of exploring the energy frontier with accelerators which is reminiscent to the exploration of the Fermi scale with HERA, the Tevatron and LEP. More information on the LHeC is collected at [www.lhec.org.uk](http://www.lhec.org.uk). The next workshop will be held at Divonne 1-3.9.2009.

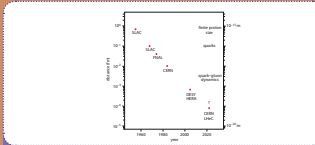
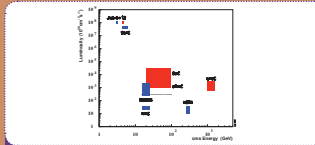
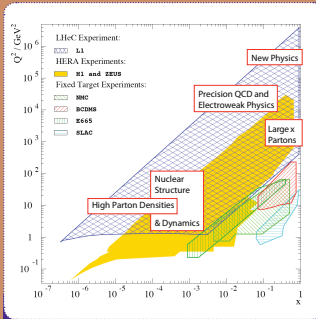

**LHeC Physics and Kinematics:** Kinematic phase in Bjorken- $x$  and resolving power  $Q^2$ , showing the coverage of fixed target experiments, HERA and the LHeC. The mapping of the planned physics programme onto this phase is also indicated.

**Lepton-Proton Scattering:** Comparison of the energies and luminosities of selected previous (blue) and proposed future (red) lepton-proton scattering facilities. The LHeC reaches DIS into the Tera scale with about 100 times the luminosity of HERA.

**Resolving Proton's Structure:** Distance scales resolved in successive lepton-nucleon scattering experiments since the 1950s, and some of the new physics revealed. The LHeC will resolve distances below  $10^{-10}$  m, more than 10000 times smaller than the proton's radius and 50 times below HERA.

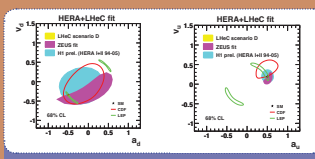
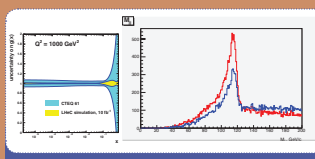
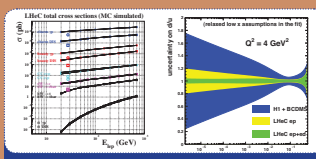

**Direct Measurement of Partons:** The LHeC permits the complete resolution of the light and heavy quark, as well as the gluon, in all order precision measurements of the hadron density, the first ever measurements of energy and anti-energy quark densities or the u/d densities at low and at large  $x$ . The LHeC is a single top end-up top-quark factory.

**Complementing the LHC:** The LHeC complements the LHC with precision measurements, e.g. on the gluon density and the investigation of the Higgs. With the LHeC, new physics phenomena possibly occurring at the LHC can be distinguished reliably from mere variations of partonic behaviour, currently subject to extrapolation and parametrisation uncertainties.

**Exploring Multi-TeV Scales:** Exploration of ultrahigh energy scales with precision measurements in electron-proton collisions. Precise determination of light weak neutral current couplings. Unification of coupling constants at the Planck scale may be tested with alpha<sub>s</sub> measured an order of magnitude more precisely than at LEP.

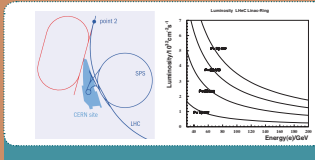
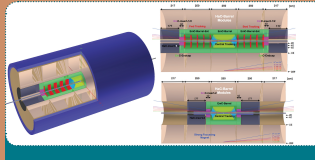
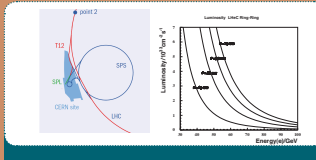

**LHeC as Ring-Ring Collider:** The LHeC as a Ring-Ring Collider may use the SPS as an injector and will have to pass around LHC experiments, in which the ring may be placed. A new type of dipole magnet is considered for installation on top of the proton ring. The luminosity is estimated to be above  $10^{31} \text{ cm}^{-2} \text{ s}^{-1}$ , with an assumed level of 100 MW wall plug power.

**A New Detector for epIxA:** The detector is modular for fast installation down the pit and to cope with the requirements of high luminosity and of large acceptance near the beam axis. Design work is ongoing on the interaction region to allow the simultaneous operation of the LHeC and the SPS beams.

**LHeC as Linac-Ring Collider:** The LHeC as a Linac-Ring Collider is considered to provide a scientific programme of EC-type experiments. The luminosity is in excess of  $10^{31} \text{ cm}^{-2} \text{ s}^{-1}$  with a power level of 100 MW based on the LHeC upgrade. It may be merged with energy recovery techniques. The luminosity diminishes as 1/E with the electron beam energy and the time may therefore surpass the energy reach of the ring.

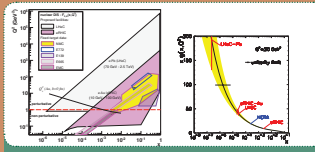
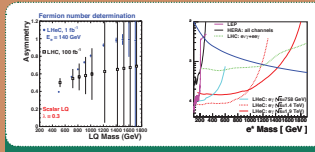
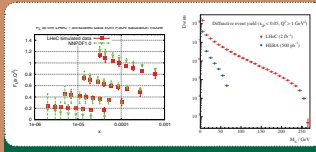

**Saturation of Parton Densities:** At small Bjorken  $x$  the rise of the parton densities is predicted to be limited by unitarity. A new phase of matter governed by modified parton dynamics with relations to nuclear and neutron analogues. This may be discovered in ep with precision measurements of  $F_2$  and  $F_L$  vector meson production or diffractive scattering in a relevant kinematical range of phase space and kinematics.

**New Physics in eq Scattering:** Single produced new states, such as ex resonances or excited leptons, have a much higher cross section at an electron than at a proton. This will allow the determination of quantum numbers of new states and possibly give access to a complementary phase space. If leptons and hadrons are new forms of matter (AdS/CFT), an LHeC is called to detect and to explore.

**Partonic Structure of Nuclei:** The LHeC extends the experimental knowledge on the partonic structure of nuclei by many orders of magnitude in  $Q^2$ . The predicted enhancement of the gluon density at low and very high energies at the LHeC allow parton saturation effects to be studied both in ep and in pA interactions and thus to compare against nuclear shadowing effects in deep inelastic scattering.

## Recent Developments

### 2008

- September Divonne workshop; NuPECC Meeting at Glasgow
- October ICFA Seminar at SLAC
- November ECFA Plenary at CERN
- December Convenor's Meeting at CERN

### 2009

- March Visit at SLAC [Linac]
- April DIS09 at Madrid: LHeC premeeting, parallel, SAC plenary panel (M.K. arXiv:0908.2877 [hep-ex])
- April PAC09 at Vancouver - Papers, Talk, Proceedings
- May Visit at BNP Novosibirsk [Ring Magnets]
- June Low  $x$  / HPD meeting at CERN, pre-Blois
- July Talk and Poster at EPS09 and Lepton-Photon
- September Divonne II (CERN-ECFA-NuPECC Workshop)
- October NuPECC Long Range Planning Workshop

# Conceptual Design Report Large Hadron Electron Collider (LHeC) at CERN

DRAFT - February 2009

Extended version by Mid December09

## 1. Introduction

## 2. Particle Physics and Deep Inelastic Lepton-Nucleon Scattering

1. DIS from 1 to 100 GeV
2. Status of the Exploration of Nucleon Structure
3. Tera Scale Physics

## 3. The Physics Programme of the LHeC

1. New Physics at Large Scales
2. Precision QCD and Electroweak Physics
3. Physics at High Parton Densities

## 4. Design Considerations

1. Acceptance and Kinematics
2. A Series of Measurements
3. Compatibility with the LHC
4. Proton, Deuteron and Ion Beams

## 5. A Ring-Ring Collider Concept

1. Injector
2. Lepton Ring
3. Synchrotron Radiation
4. Interaction Region
5. Installation
6. Infrastructure and Cost

## 6. A Linac-Ring Collider Concept

1. Electron and Positron Sources, Polarisation
2. Linac
3. Interaction Region
4. Beam Dump
5. Infrastructure and Cost

## 7. A Detector for the LHeC

1. Dimensions and General Requirements
2. Coil
3. Calorimeters
4. Tracking
5. Options for the Inner Detector Region
6. Detector Simulation and Performance

## 8. Summary

1. Physics Highlights
2. Parameters
3. Concluding Remarks

## Appendix

1. Tasks for a TDR
2. Building and Operating the LHeC

# Physics Programme of the LHeC

- + Unfolding completely the **parton structure of the proton** (neutron and photon) and search for sub-substructure down to ten times below HERA's limit
- + Sensitive exploration of **new symmetries and the grand unification** of particle interactions with electroweak and strong interaction measurements of unprecedented precision.
- + Search for and exploration of **new, Terascale physics**, in particular for singly produced new states (RPV SUSY, LQ, excited fermions) complementary to the LHC
- + Exploration of **high density matter** [low x physics beyond the expected unitarity limit for the growth of the gluon density]
- + Unfolding the substructure and **parton dynamics inside nuclei** by an extension of the kinematic range by four orders of magnitude [initial state of the QGP]

**Huge amount of studies done and ongoing. Follows one example per point each**

# Strange and Anti-Strange Quark Distributions

Not measured with H1,ZEUS  
 HERMES ( $N_K$ ):  $s$  much larger?  
 Dimuon data:  $s \neq s\bar{s}$ ?

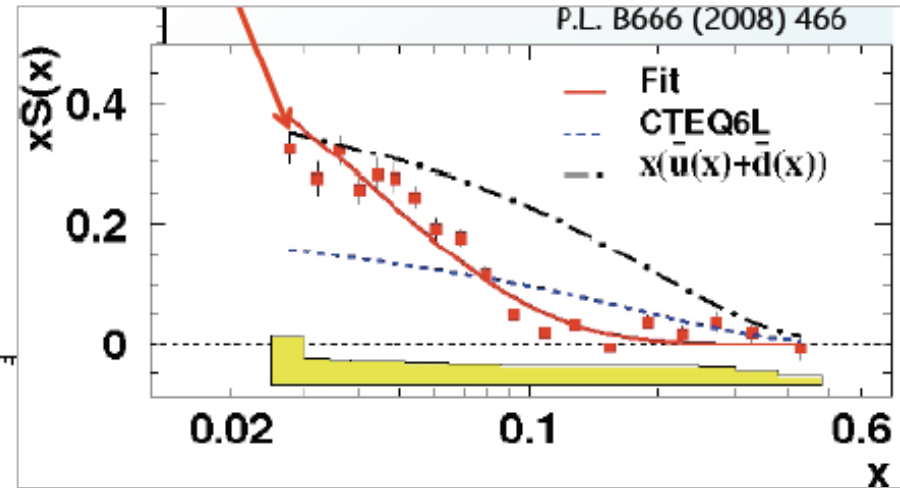

HERMES, K.Rith EPS09

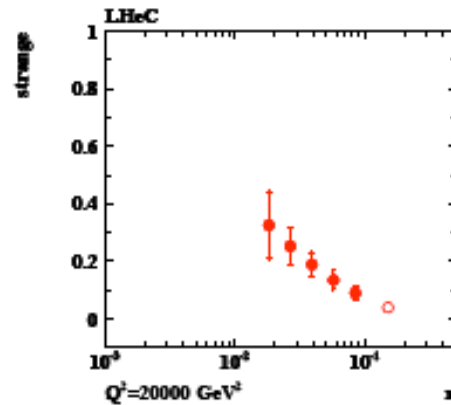
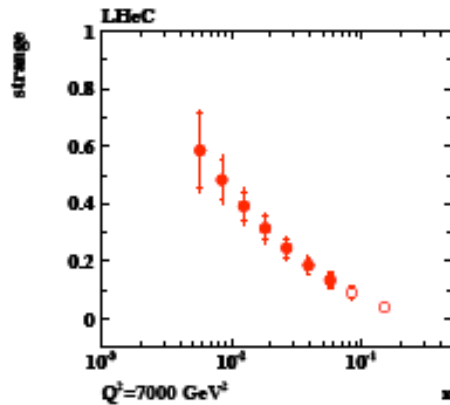
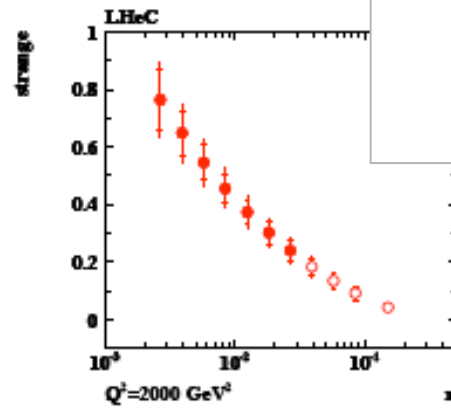
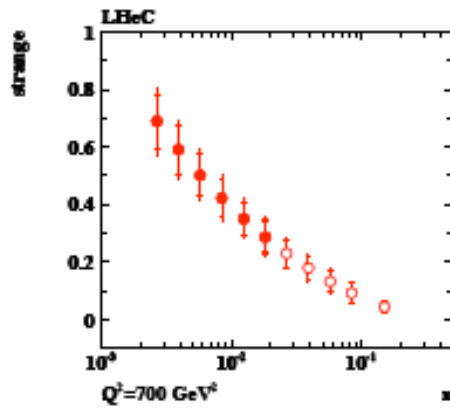

$Q^2 \sim 1 \text{ GeV}^2$

$W^- s\bar{s} \rightarrow c\bar{c}$   
 $1 \text{ fb}^{-1}$   
 $\epsilon_c = 0.1$   
 $\epsilon_q = 0.01$   
 $\delta_{\text{sys}} = 0.1$   
 $\circ - \vartheta_h \geq 1^\circ$   
 $\bullet - \vartheta_h \geq 10^\circ$

W,Z sensitive to  $s$

**LHeC: measure both  
 strange and anti-s  
 with high precision  
 for the first time**

# Strong Coupling Constant

Simulation of  $\alpha_s$  measurement at LHeC

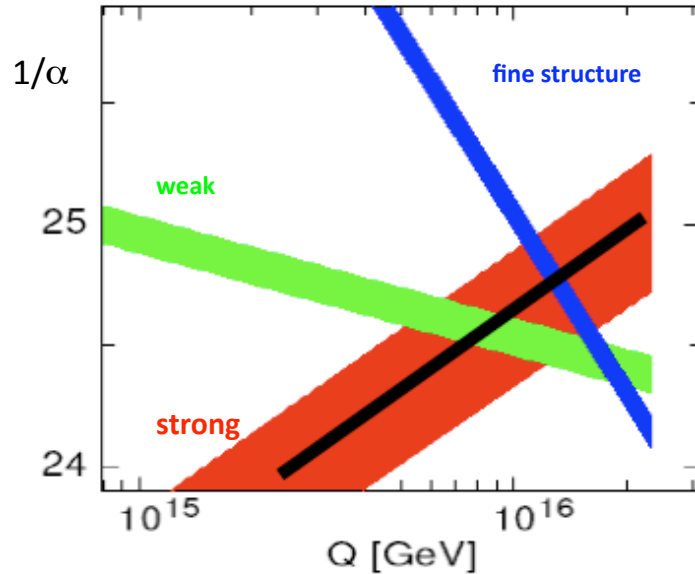

MSSM - B.Allnach et al, hep-ex/0403133

DATA	exp. error on $\alpha_s$
NC e <sup>+</sup> only	0.48%
NC	0.41%
<b>NC &amp; CC</b>	<b>0.23% :=<sup>(1)</sup></b>
<sup>(1)</sup> $\gamma_h > 5^\circ$	0.36% := <sup>(2)</sup>
<sup>(1)</sup> +BCDMS	0.22%
<sup>(2)</sup> +BCDMS	0.22%
<sup>(1)</sup> stat. *= 2	0.35%

$\alpha_s$  least known of coupling constants

Grand Unification predictions suffer from  $\delta\alpha_s$

DIS tends to be lower than world average

LHeC: per mille accuracy indep. of BCDMS.

Challenge to experiment and to h.o. QCD

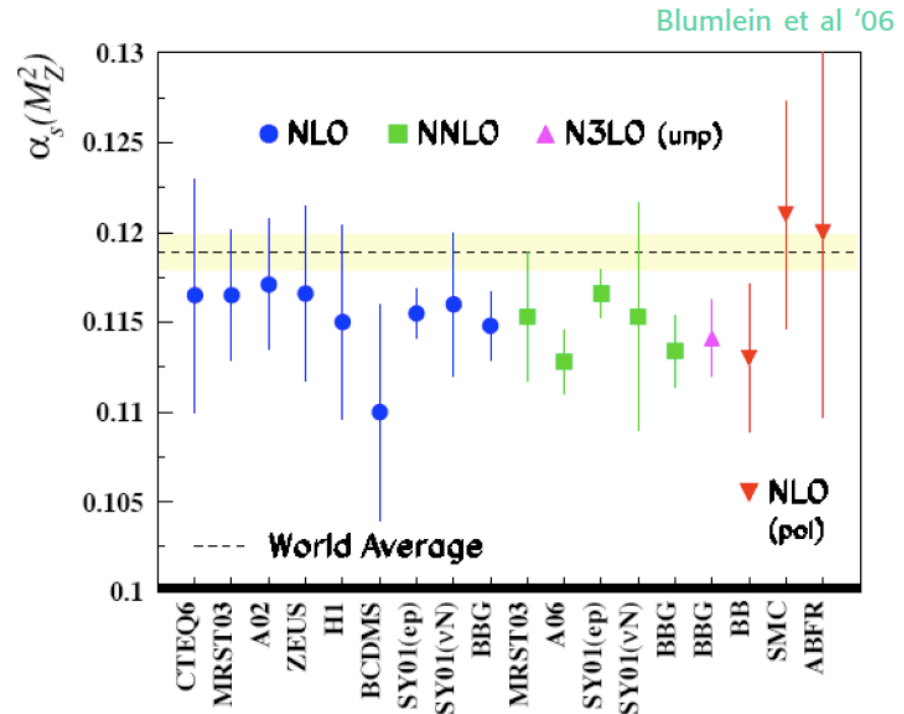

# High Precision Electroweak Physics

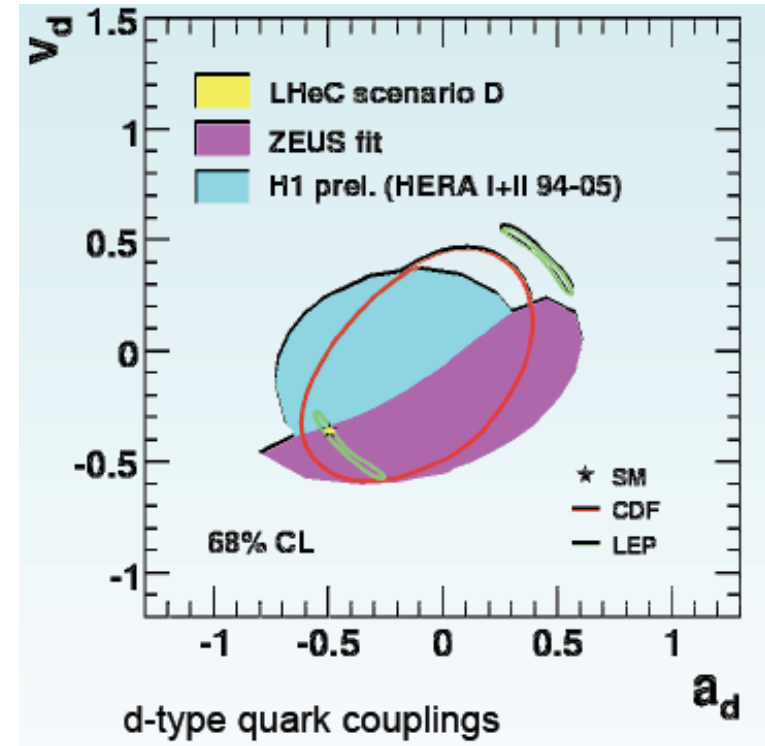
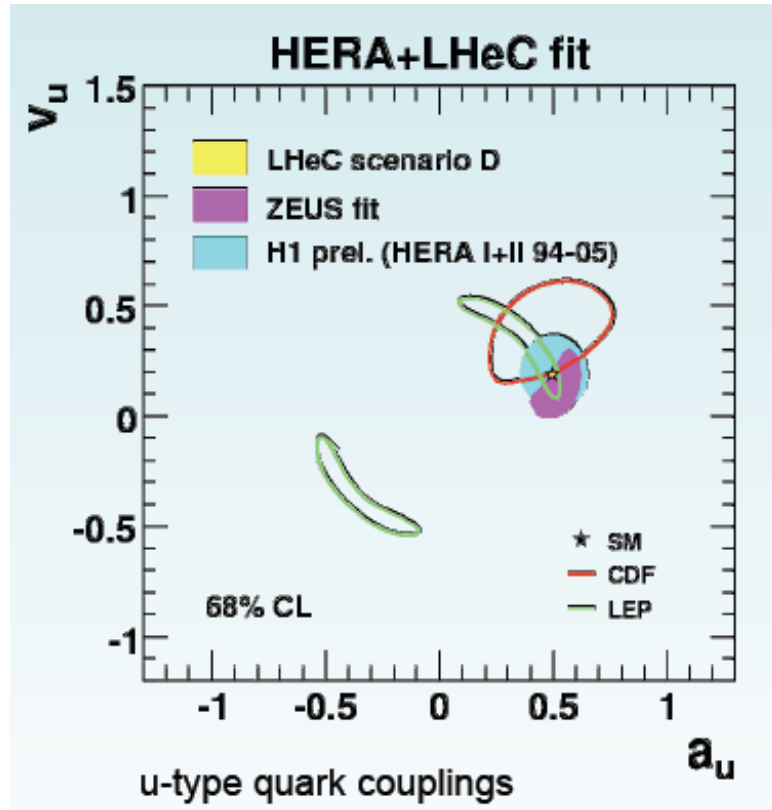

Precision measurement of weak neutral current couplings (+pdf's): access to new el.weak physics.

40 TeV limits on Contact Interactions and correspondingly on extra dimensions

Search for eq bound states and sub-substructure to  $6 \cdot 10^{-20}m$  – [LHeC: the world's new microscope](#)

# Gluon - SM Higgs

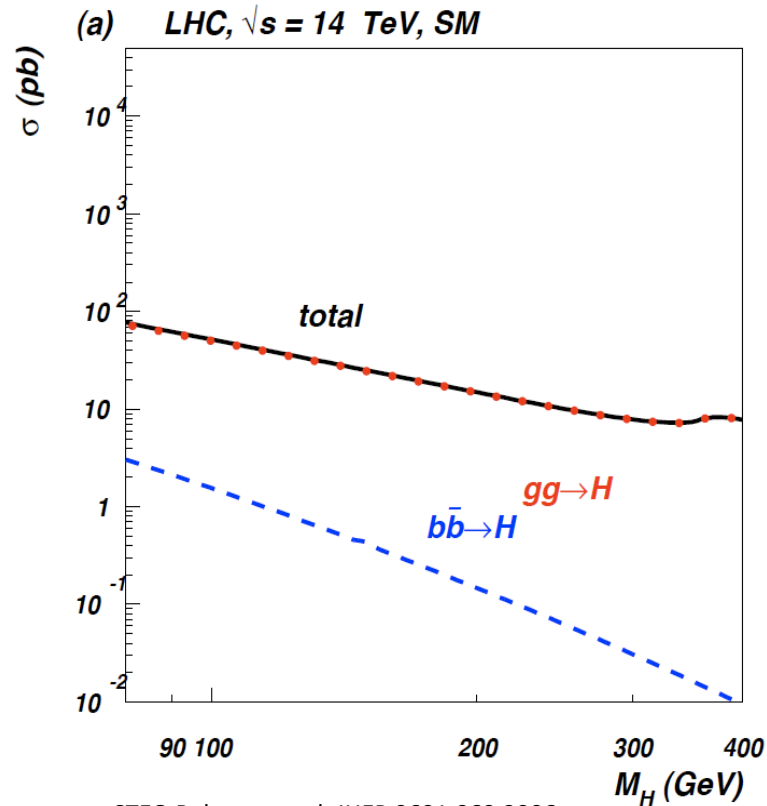

CTEQ Belyayev et al. JHEP 0601:069,2006

In SM Higgs production is gluon dominated

LHeC: huge  $x, Q^2$  range for  $xg$  determination

WW to Higgs fusion has sizeable ep xsection

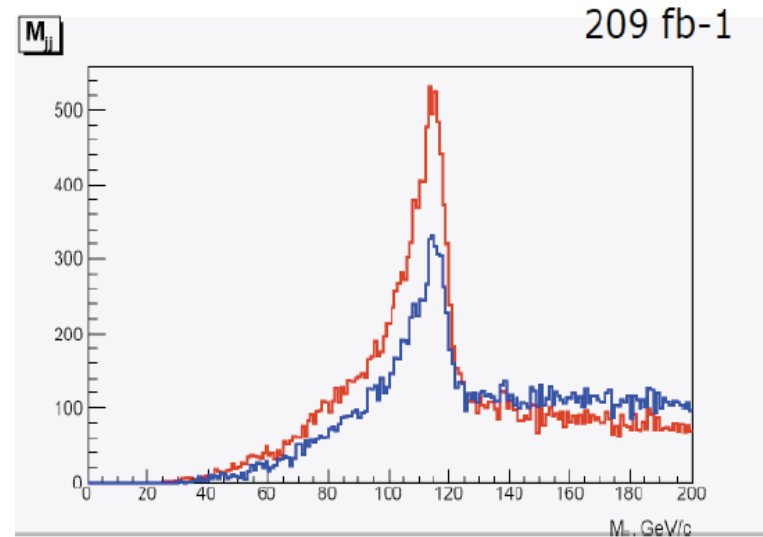
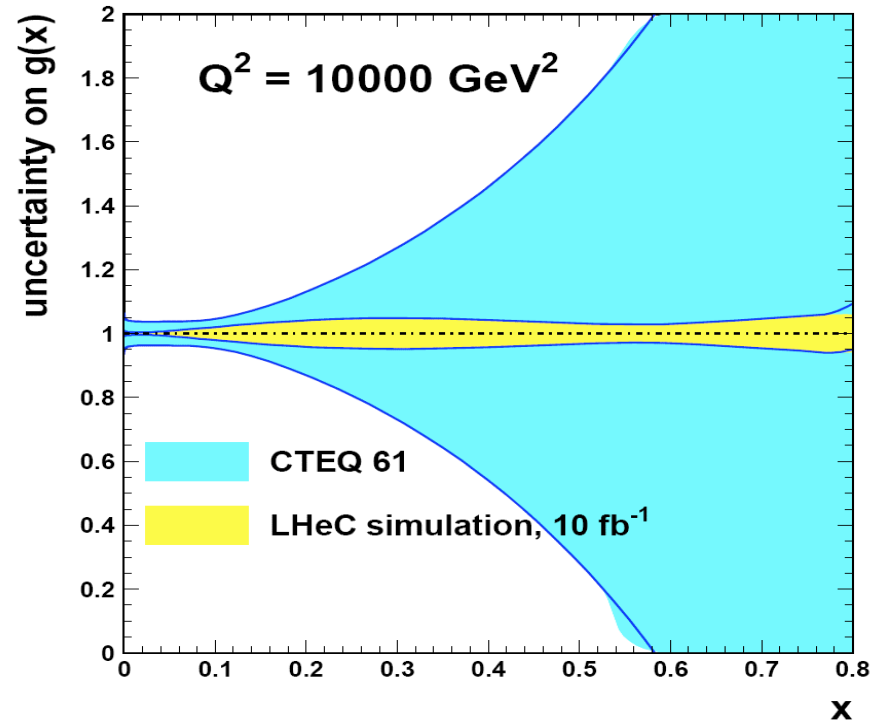

Cf Divonne 09 for QCD bgd studies + btagging



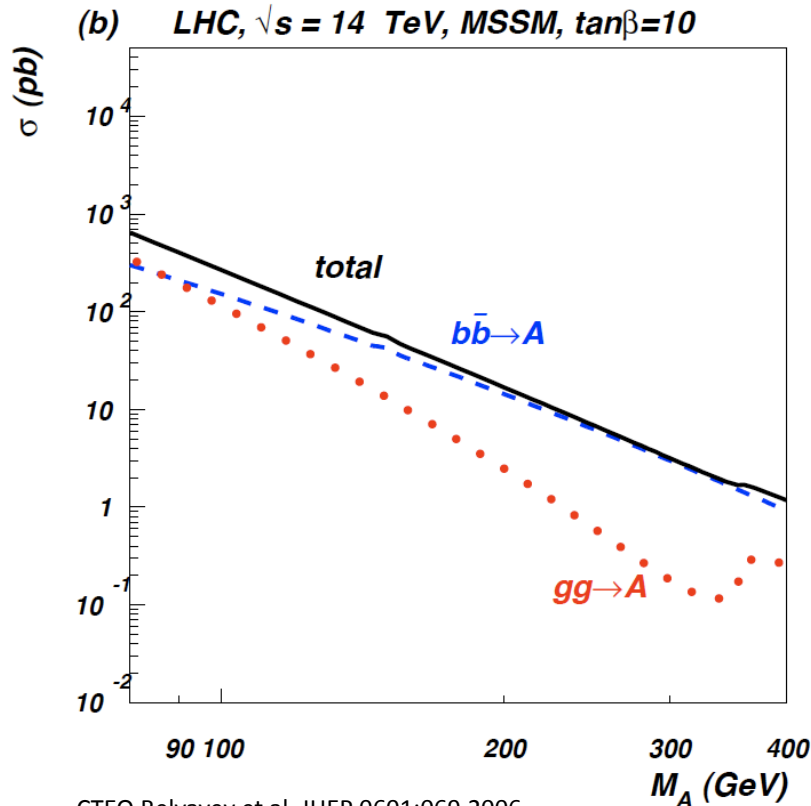

In MSSM Higgs production is b dominated

First measurements of b at HERA can be turned to precision measurement of b-df.

LHeC: higher fraction of b, larger range, smaller beam spot, better Si detectors

## Beauty - MSSM Higgs

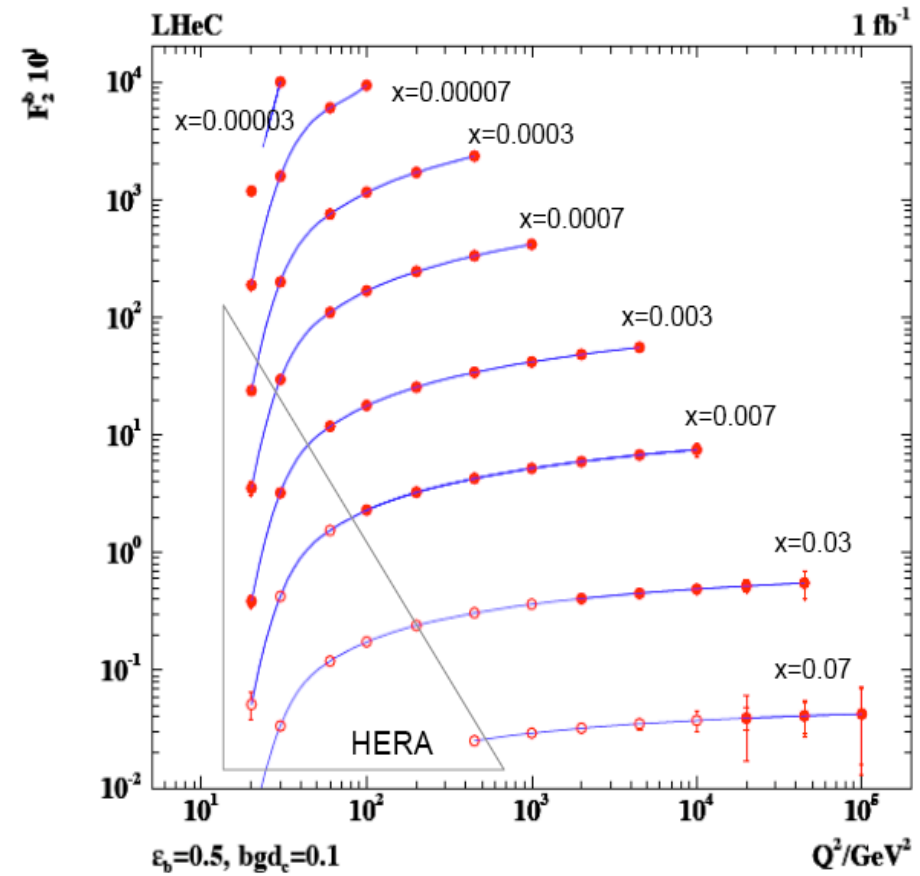

# Nuclear Structure and Dynamics

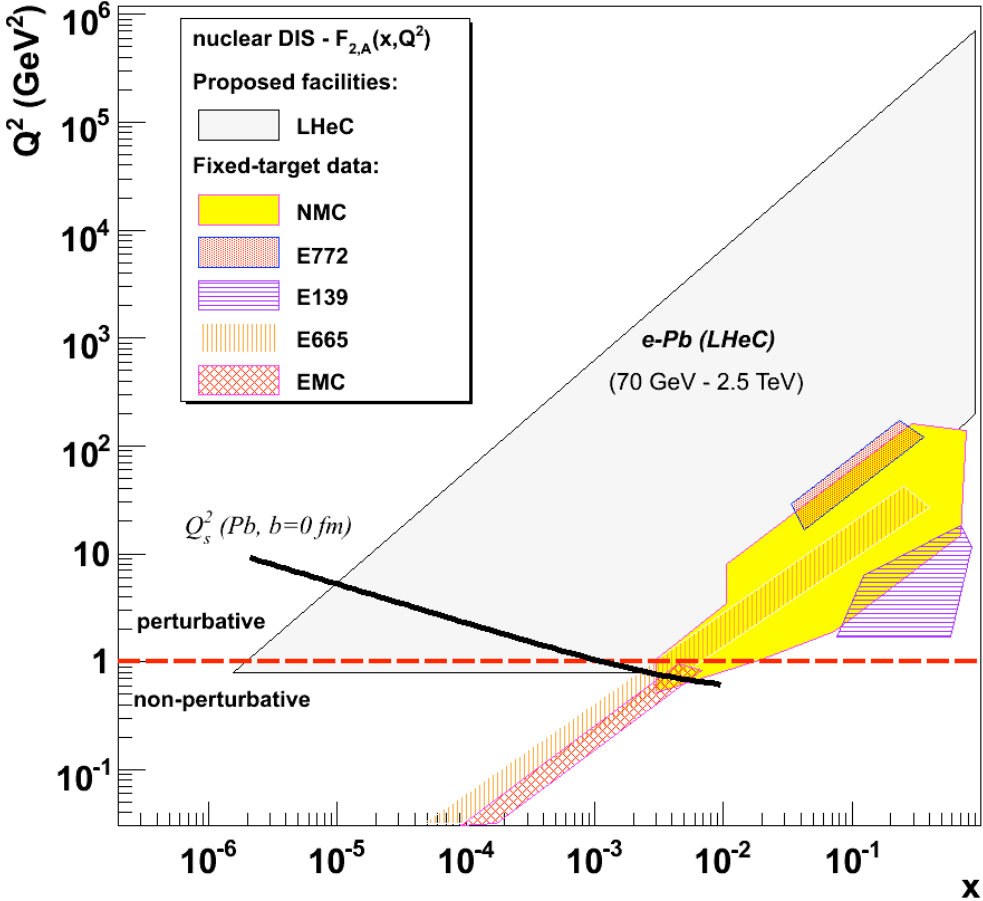
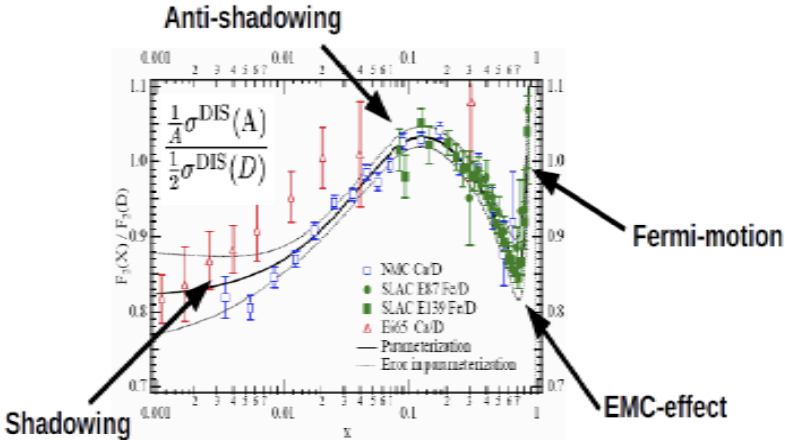

Extension of  $Q^2$ ,  $1/x$  range by  $10^4$

Fermi motion -- p tagging  
 Shadowing -- diffraction

p, D, Ca, Pb beams

Complete determination of nPDFs into nonlinear regime  
 LHeC is bound to discover parton saturation in eA AND ep  
 Determination of the initial state of the Quark Gluon Plasma

# Physics – Work in Progress

## **Various subjects are being completed**

Higgs background

Single top reconstruction

RPVSUSY

4<sup>th</sup> generation fermions

Photoproduction (real and virtual)

...

**Closer link to detector (Simulation efforts)**

**Closer look to LHC-LHeC complementarity**

# Ring-Ring ep/eA

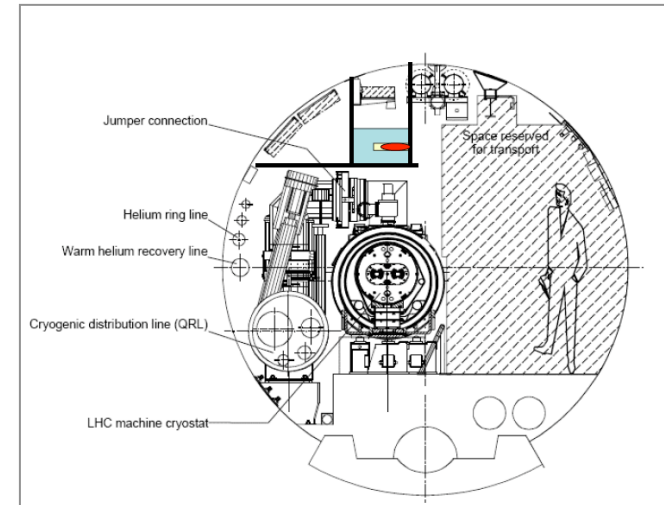
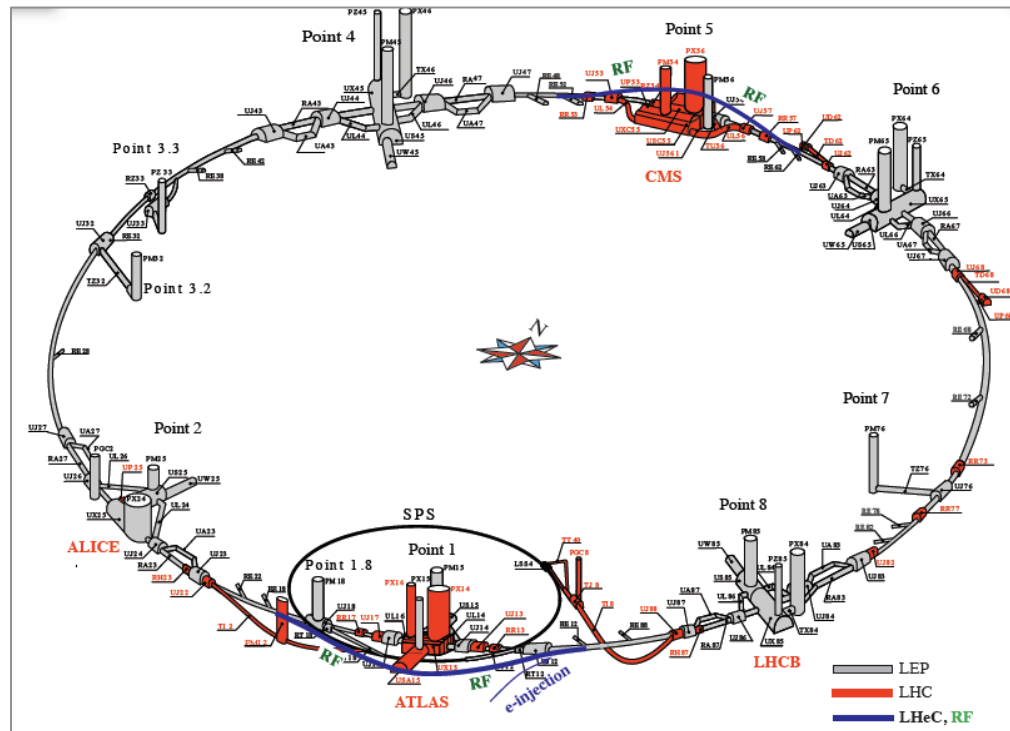

$E_e = 10 \dots 80 \text{ GeV}$ .  $L_{ep} \sim 10^{33} \text{ cm}^{-2} \text{ s}^{-1}$  (100 times HERA)

$1/x$  and  $Q^2 \sim 10^{4(2)}$  times larger in eA (ep) than so far

**Collaborations of CERN with Cockcroft, DESY, Lausanne, Novosibirsk, SLAC accelerator experts**

# RR Luminosity and Parameters

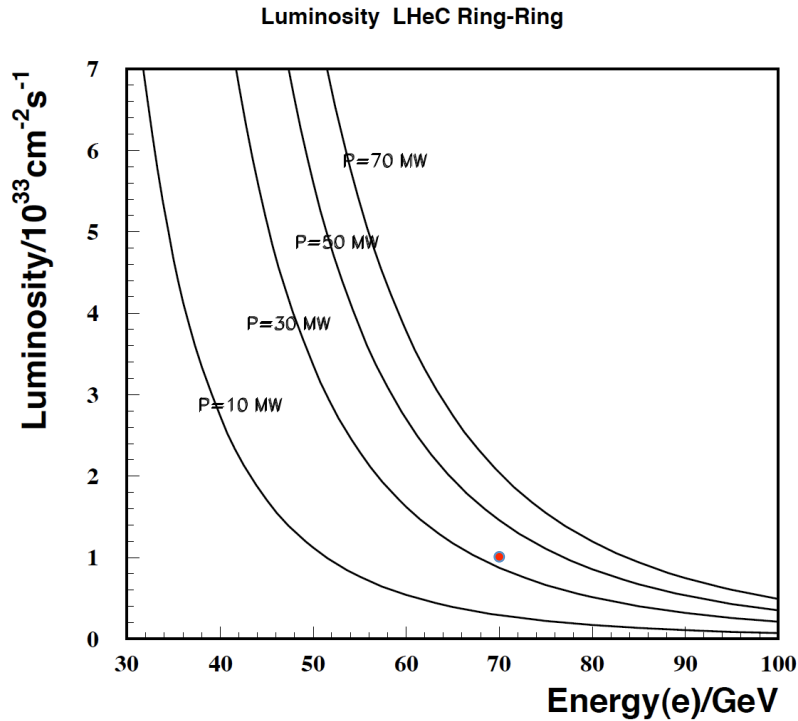

$$L = \frac{N_p \gamma}{4\pi e \epsilon_{pn}} \cdot \frac{I_e}{\sqrt{\beta_{px} \beta_{py}}} = 8.310^{32} \cdot \frac{I_e}{50mA} \cdot \frac{m}{\sqrt{\beta_{px} \beta_{pn}}} \text{ cm}^{-2} \text{ s}^{-1}$$

$$I_e = 0.35mA \cdot \frac{P}{MW} \cdot \left( \frac{100GeV}{E_e} \right)^4$$

Luminosity for  $e^\pm p$  safely above  $10^{33} \text{ cm}^{-2} \text{ s}^{-1}$

Used “ultimate” LHC beam parameters

Energy limited by injection and rf (<80 GeV)

Power limit set to 100 MW

Small p tuneshift – simultaneous pp and ep

Ultimate Parameter	Protons	Electrons	
	$Np=1.7*10^{11}$	$Ne=1.4*10^{10}$	$nb=2808$
	$Ip=860mA$	$Ie=71mA$	
Optics	$\beta_{xp}=230 \text{ cm}$	$\beta_{xe}=12.7 \text{ cm}$	
	$\beta_{yp}=60 \text{ cm}$	$\beta_{ye}=7.1 \text{ cm}$	
	$\epsilon_{xp}=0.5 \text{ nm rad}$	$\epsilon_{xe}=9 \text{ nm rad}$	
	$\epsilon_{yp}=0.5 \text{ nm rad}$	$\epsilon_{ye}=4 \text{ nm rad}$	
Beamsize	$\sigma_x=34 \mu\text{m}$		
	$\sigma_y=17 \mu\text{m}$		
Tuneshift	$\Delta\nu_x=0.00061$	$\Delta\nu_x=0.056$	
	$\Delta\nu_y=0.00032$	$\Delta\nu_y=0.062$	
Luminosity	$L=1.03*10^{33}$		

# e Ring – Optics

## Optics in the arcs

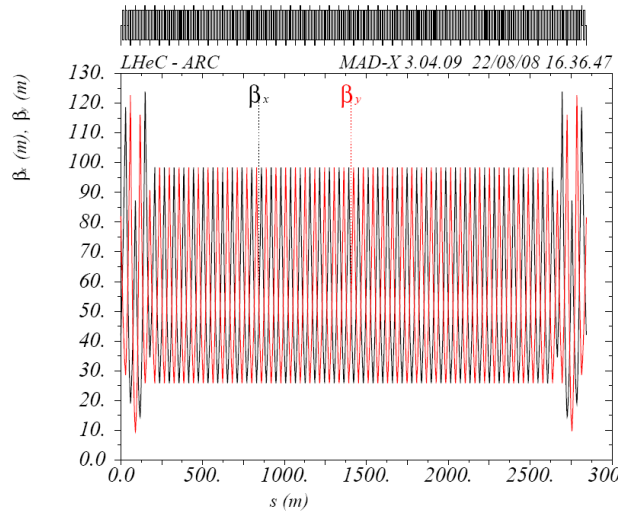

$\beta$  functions for LHeC - 2008

Dispersion was 50-90cm

and horiz. emittance 22 nm

384 60m long cells

2009: optimisation of FODO cell

Dispersion reduced to 20-50cm

emittance  $\epsilon_x=7.5\text{nm}$   $\epsilon_y=3.7\text{nm}$

**MEDIUM or WEAK BEND SOLUTION**

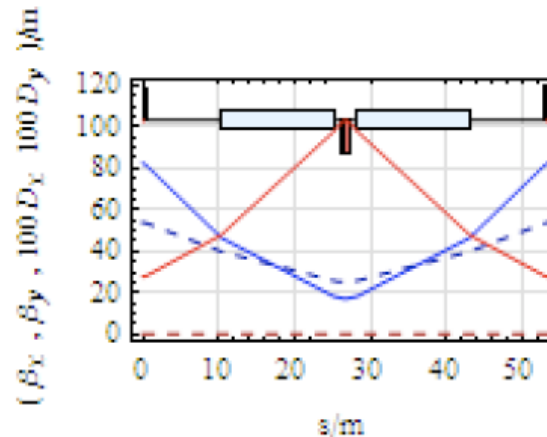

**FODO optimisation**

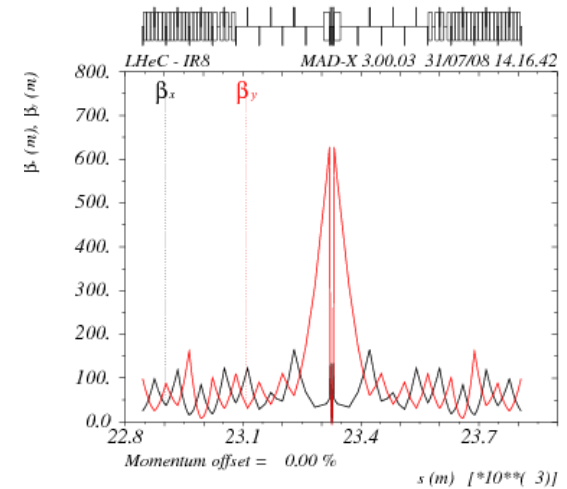

“inner” triplet focus

$\beta_x=7.1\text{cm}$   $\beta_y=12.7\text{cm}$

Mini beta design

# Dipole Magnets

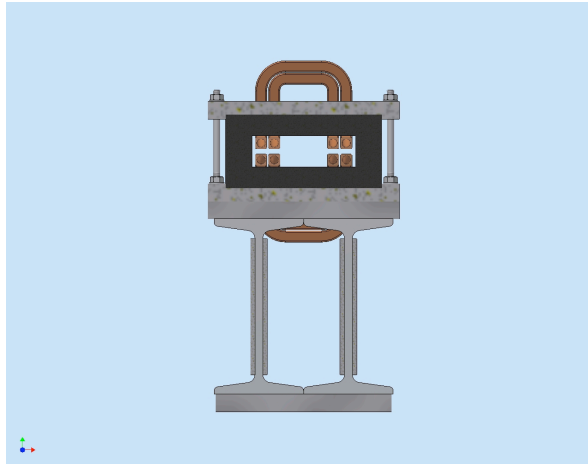

O-shaped magnet with ferrite core [BNP-CERN]

Accelerator	LEP	LHeC
Cross Section/ cm <sup>2</sup>	50 x 50	20 x 10
Magnetic field/ T	0.02-0.11	0.02-0.135
Energy Range/GeV	20-100	10-70
Good Field Area/cm <sup>2</sup>	5.9 x 5.9	6 x 3.8
FODO length/m	76	53
Magnet length/m	2 x 34.5	2 x 14.76
segmentation	6 cores	14
Number of magnets	736	488
Weight / kg/m	800	240

Prototype design under way at Novosibirsk, May 2010

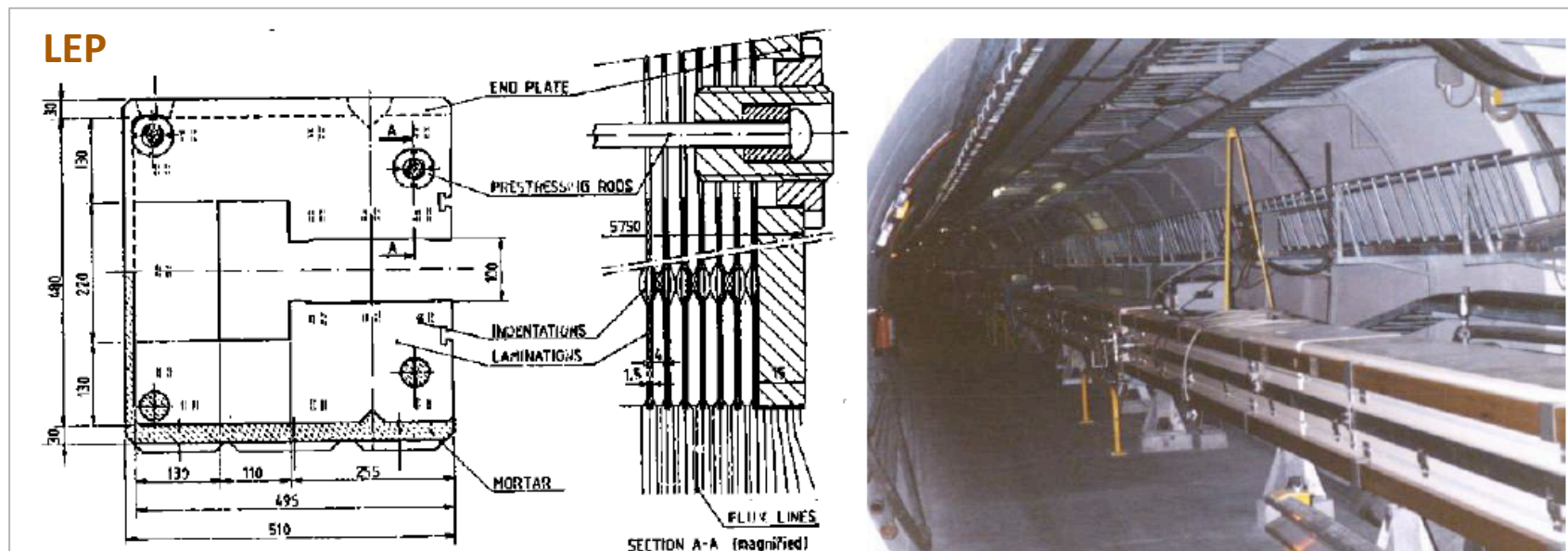

# Ring – Work in progress

## Interaction region design

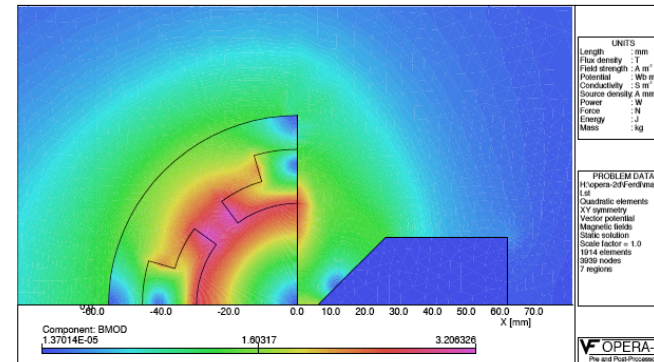
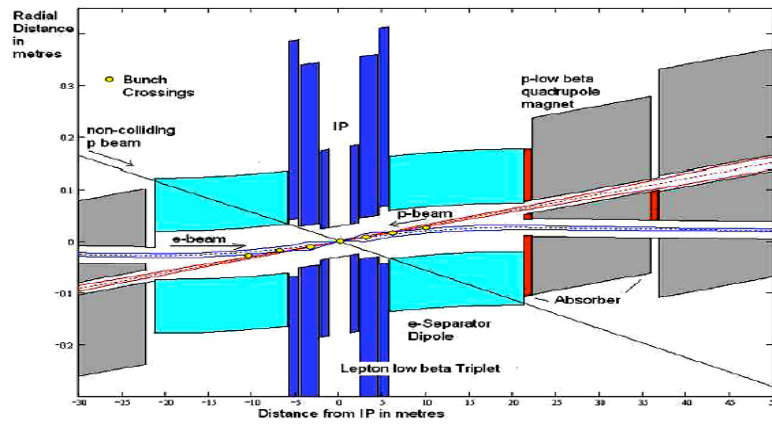

## Installation study

Systematic investigation of clashes with LHC installation and possible ways 'around'

## Polarisation

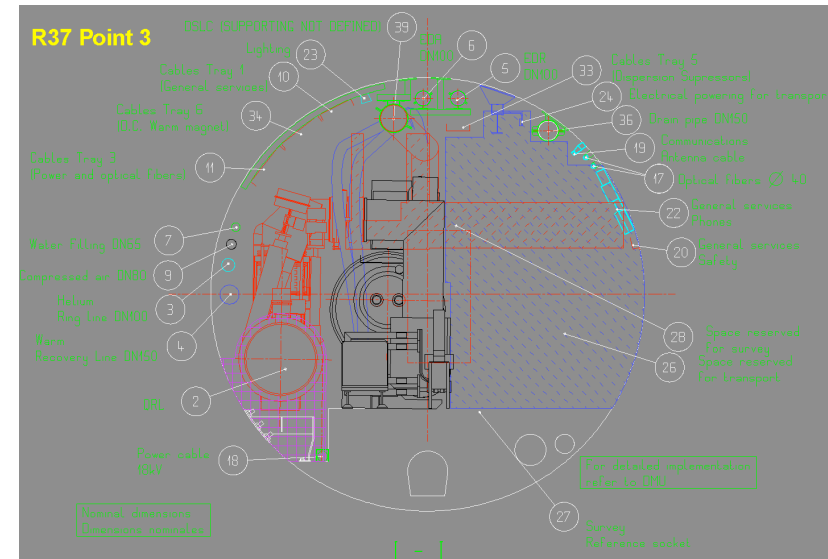



$$L = \frac{N_p \gamma}{4\pi e \epsilon_{pn} \beta^*} \cdot \frac{P}{E_e} = 5 \cdot 10^{32} \cdot \frac{P / MW}{E_e / GeV} cm^{-2} s^{-1}$$

# Linac-Ring ep/eA

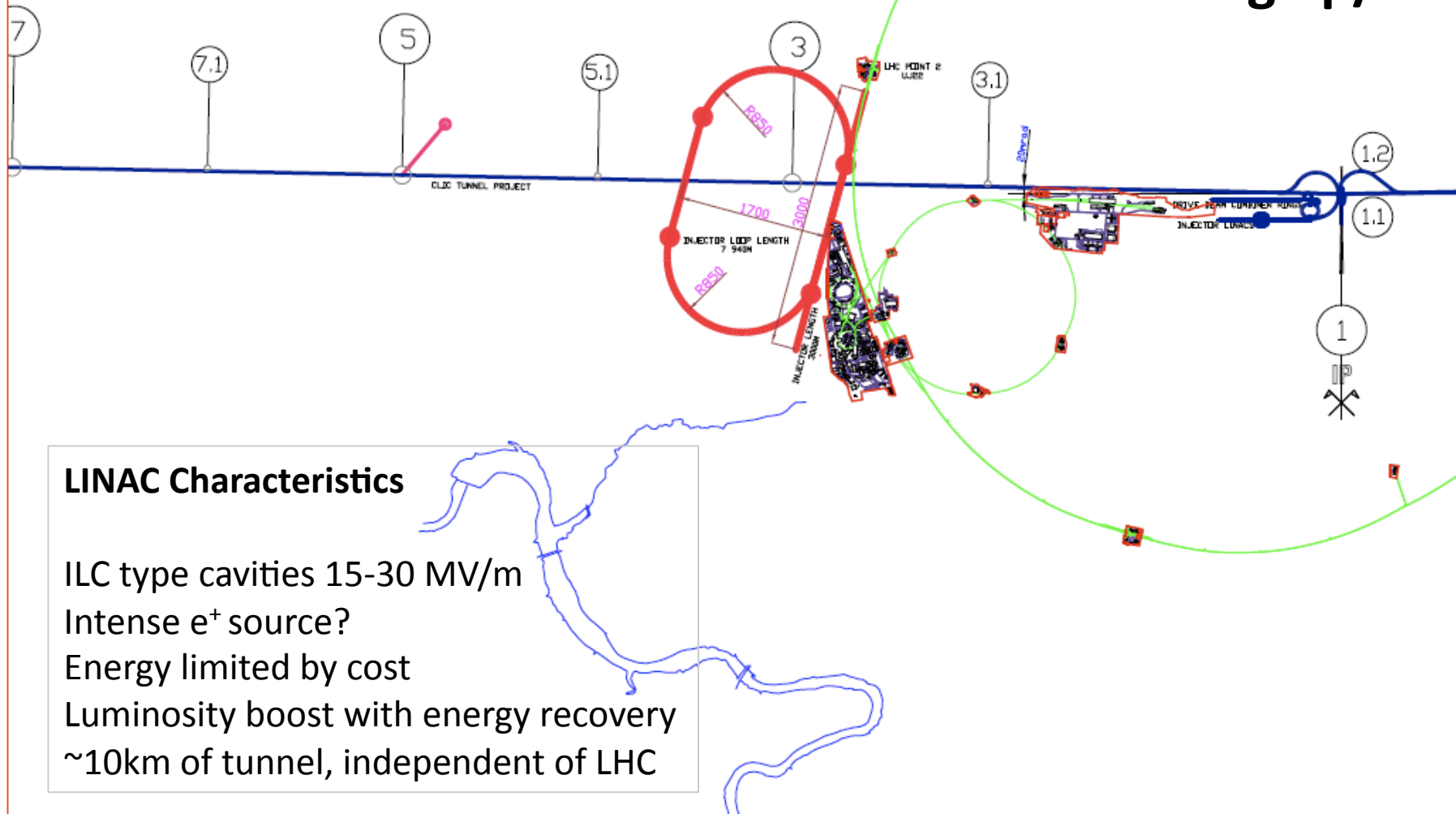

## LINAC Characteristics

- ILC type cavities 15-30 MV/m
- Intense e<sup>+</sup> source?
- Energy limited by cost
- Luminosity boost with energy recovery
- ~10km of tunnel, independent of LHC



## Three LINAC Configurations [CERN-SLAC]

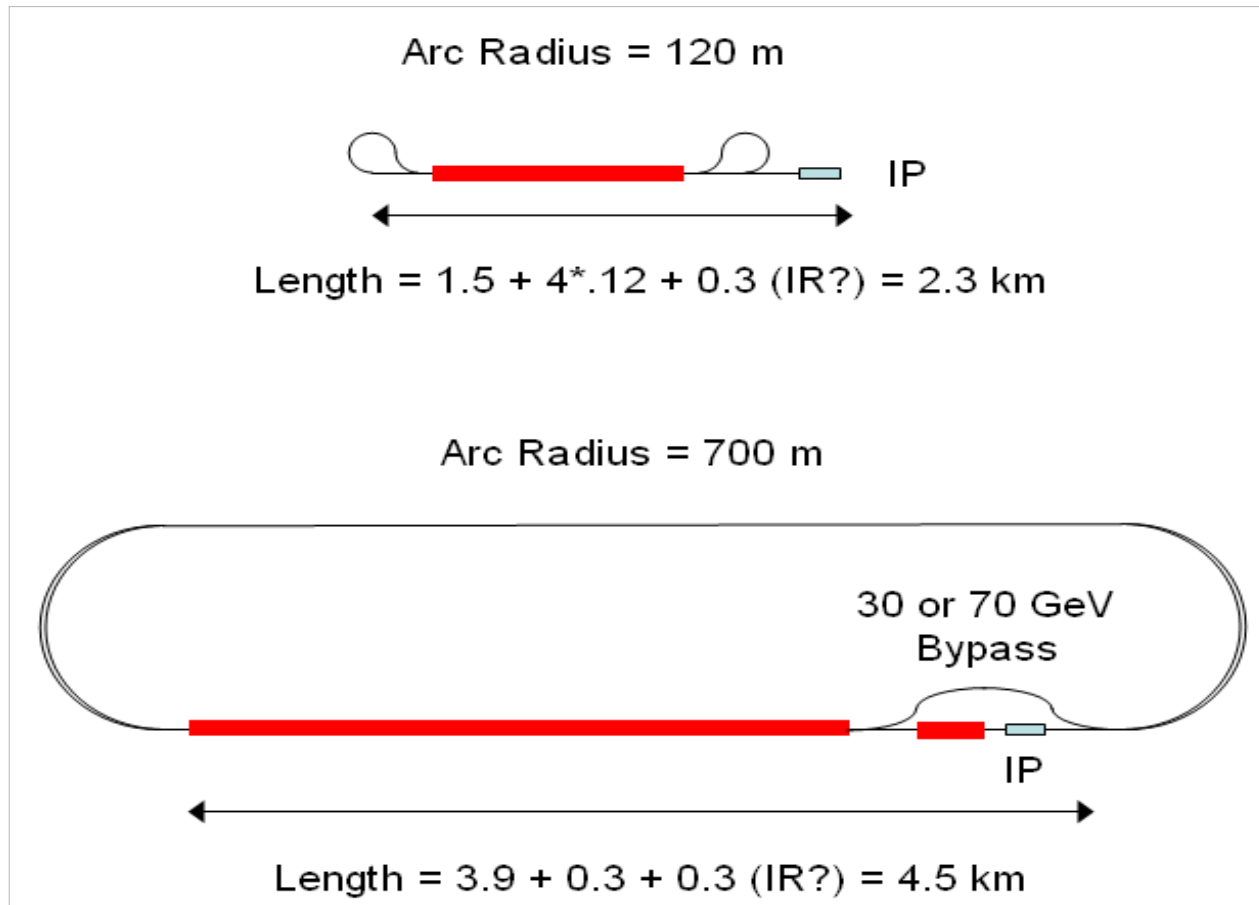

60 GeV  
31 MV/m, pulsed  
two passes.  $2 \cdot 10^{32}$

60 GeV  
13 MV/m CW ERL  
4 passes  $3 \cdot 10^{33}$

140 GeV  
31 MV/m, pulsed  
2 passes  $2 \cdot 10^{32} \text{ cm}^{-2} \text{ s}^{-1}$

Luminosities for  $e^-$  and SLHC

# A slide on LINAC design work

Being done with Frank

# A slide on LINAC work in progress

Being done with Frank

## Muon chambers

(fwd,bwd,central)

## Coil (r=3m I=8.5m, 2T)

[Return Fe not drawn,

2 coils w/o return Fe studied]

## Central Detector

### Hadronic Calo (Fe/LAr)

### El.magn. Calo (Pb,Sc)

### GOSSIP (fwd+central)

[Gas on Slimmed Si Pixels]

[0.6m radius for 0.05% \* pt in 2T field]

Pixels

Elliptic beam pipe (~3cm)

## Fwd Spectrometer

(down to 1°)

## Tracker

Calice (W/Si)

FwdHadrCalo

## Bwd Spectrometer

(down to 179°)

## Tracker

Spacal (elm, hadr)

# LHeC Detector: version for low x and eA

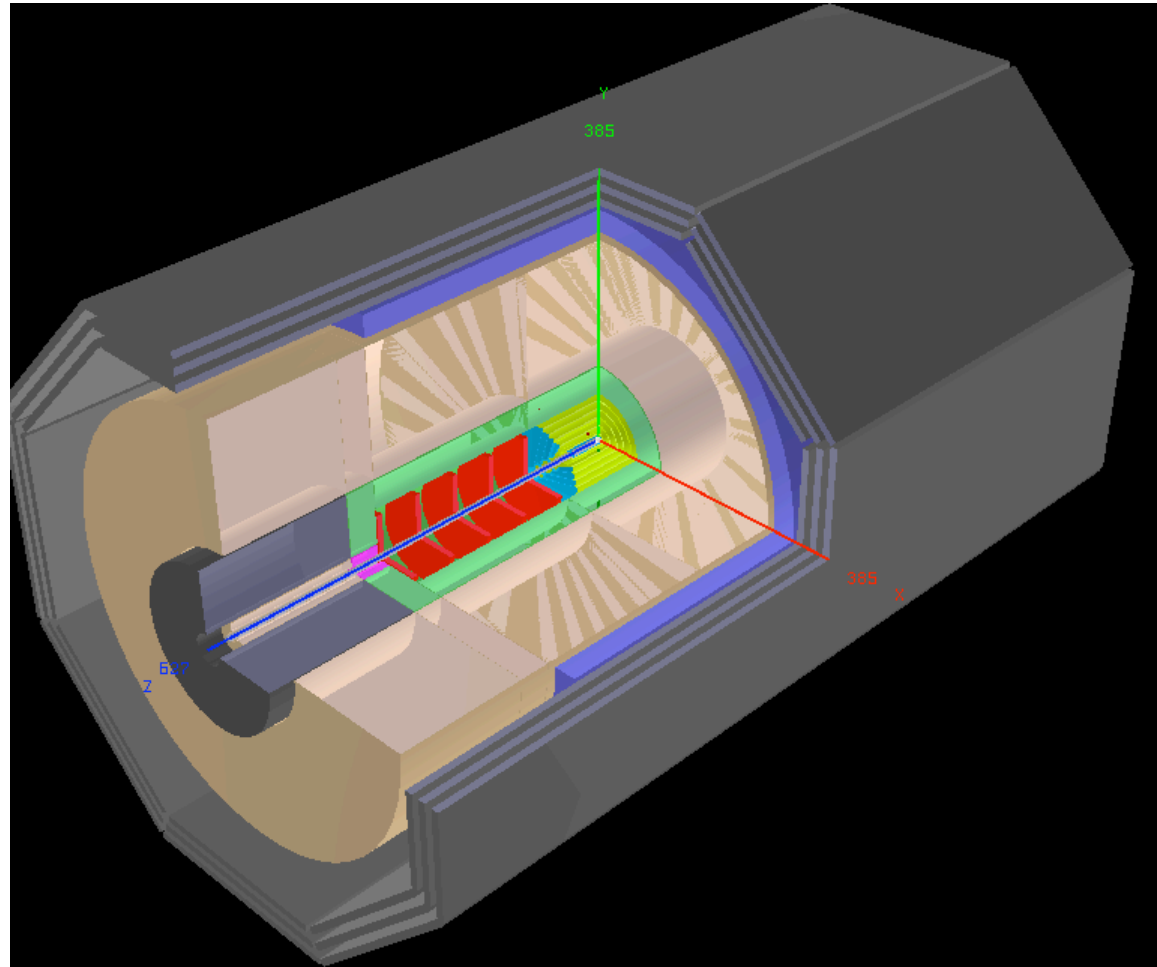

April2009

Extensions in fwd direction (tag p,n,d) and backwards (e, $\gamma$ ) under study.

## Scientific Advisory Committee

Guido Altarelli (Rome)  
Sergio Bertolucci (CERN)  
Stan Brodsky (SLAC)  
Allen Caldwell -chair (MPI Munich)  
Swapan Chattopadhyay (Cockcroft)  
John Dainton (Liverpool)  
John Ellis (CERN)  
Jos Engelen (CERN)  
Joel Feltesse (Saclay)  
Lev Lipatov (St.Petersburg)  
Roland Garoby (CERN)  
Roland Horisberger (PSI)  
Young-Kee Kim (Fermilab)  
Aharon Levy (Tel Aviv)  
Karlheinz Meier (Heidelberg)  
Richard Milner (Bates)  
Joachim Mnich (DESY)  
Steven Myers, (CERN)  
Tatsuya Nakada (Lausanne, ECFA)  
Guenter Rosner (Glasgow, NuPECC)  
Alexander Skrinsky (Novosibirsk)  
Anthony Thomas (Jlab)  
Steven Vigdor (BNL)  
Frank Wilczek (MIT)  
Ferdinand Willeke (BNL)

## Steering Committee

Oliver Bruening (CERN)  
John Dainton (Cockcroft)  
Albert DeRoeck (CERN)  
Stefano Forte (Milano)  
Max Klein - chair (Liverpool)  
Paul Newman (Birmingham)  
Emmanuelle Perez (CERN)  
Wesley Smith (Wisconsin)  
Bernd Surrow (MIT)  
Katsuo Tokushuku (KEK)  
Urs Wiedemann (CERN)

# Completion of the CDR

## Steps to go in 2010

1. Finalise physics and technical studies
2. DIS10 Firenze [April] and IPACC Japan [May]
3. Draft CDR June 2010
4. Divonne III – Updates and Discussion with referees
5. November 10: Final report to ECFA
6. Submit CDR to CERN, ECFA, NuPECC

**LHeC relies on expertise and enthusiasm of many colleagues and support by you, NuPECC and CERN**



LHeC barack 561 in a protected area

## Working Group Convenors

### Accelerator Design [RR and LR]

Oliver Bruening (CERN),  
John Dainton (CI/Liverpool)

### Interaction Region and Fwd/Bwd

Bernhard Holzer (DESY),  
Uwe Schneekloth (DESY),  
Pierre van Mechelen (Antwerpen)

### Detector Design

Peter Kostka (DESY),  
Rainer Wallny (UCLA),  
Alessandro Polini (Bologna)

### New Physics at Large Scales

George Azuelos (Montreal)  
Emmanuelle Perez (CERN),  
Georg Weiglein (Durham)

### Precision QCD and Electroweak

Olaf Behnke (DESY),  
Paolo Gambino (Torino),  
Thomas Gehrman (Zuerich)  
Claire Gwenlan (Oxford)

### Physics at High Parton Densities

Nestor Armesto (Santiago),  
Brian Cole (Columbia),  
Paul Newman (Birmingham),  
Anna Stasto (PennState)

Backup slides

# Dipole Magnet Comparison

Accelerator	LEP	LHeC
Cross Section/ cm <sup>2</sup>	50 x 50	20 x 10
Magnetic field/ T	0.02-0.11	0.02-0.135
Energy Range/GeV	20-100	10-70
Good Field Area/cm <sup>2</sup>	5.9 x 5.9	6 x 3.8
FODO length/m	76	53
Magnet length/m	2 x 34.5	2 x 14.76
segmentation	6 cores	14
Number of magnets	736	488
Weight / kg/m	800	240



# Quark Gluon Plasma

Landau 1953. **RHIC**: QGP strongly coupled plasma with liquid behaviour instead of weakly interacting gas of partons

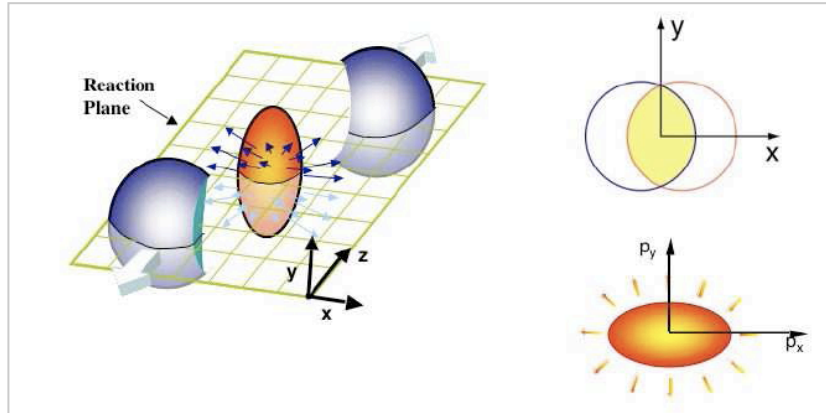

Related to cold atoms and to superstring theory [AdS/CFT]

M.Tannenbaum, Rept.Prog.Phys 65 (2006) 2005

Collective flow in non-central collisions anisotropic

Anisotropy proportional to  $1/\text{viscosity}$  of fireball, dominantly elliptic (" $v_2$ " coefficient)

QGP most perfect liquid – smallest shear viscosity/entropy

Conclusions depend on initial fireball eccentricity

**eA to measure the initial conditions of QGP.**

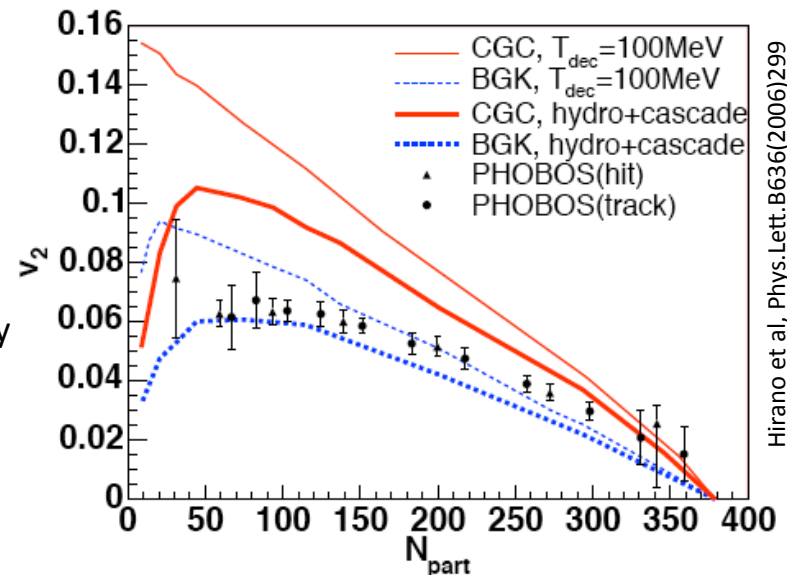

Hirano et al, Phys.Lett.B636(2006)299

U.Heinz arXiv:0907.4256 (nucl.th)

# Quark-Gluon Dynamics - Diffraction and HFS (fwd jets)

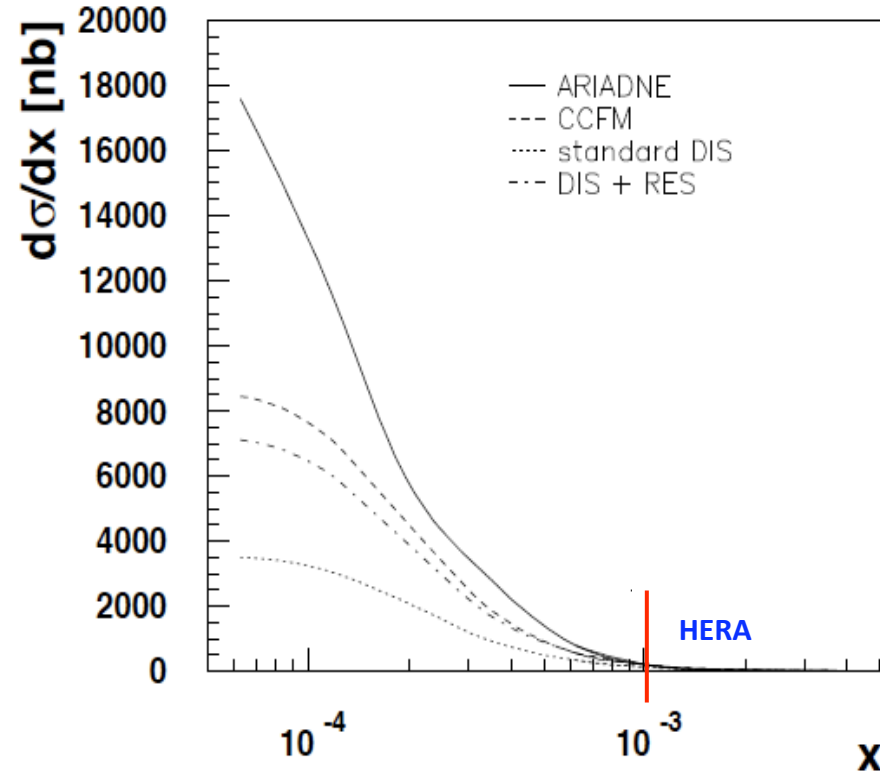
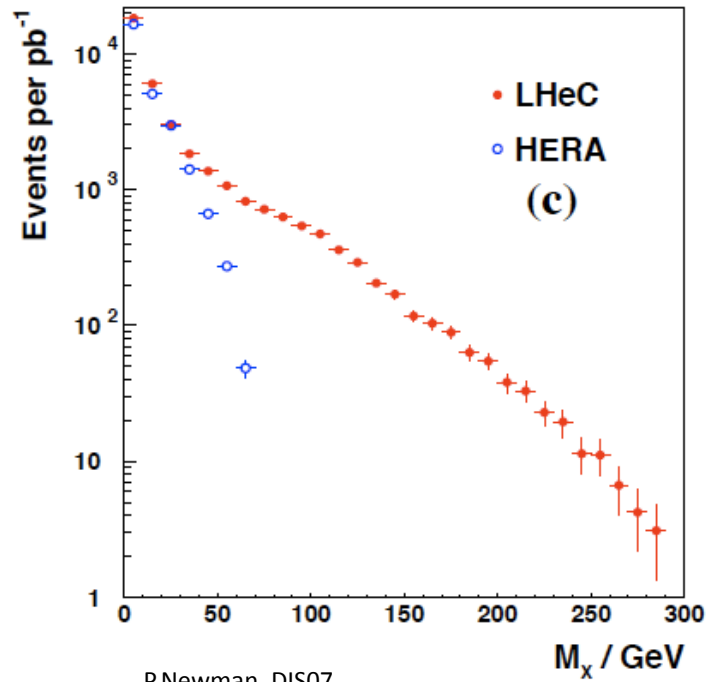
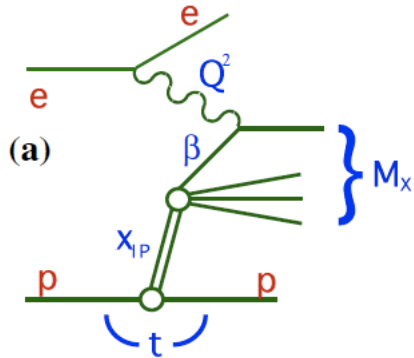

H.Jung, L.Loennblad, THERA study

Diffraction to accompany (SUSY) Higgs fwd physics at LHC

Understand multi-jet emission (unintegr. pdf's), tune MC's  
At HERA resolved  $\gamma$  effects mimic non-kt ordered emission  
Crucial measurements for QCD, and for QCD at the LHC