

Reminiscences and Outlook

a personal, selected view on 30 years of H1

Past Times in Old Books
A bit of Science
Pictures
DIS in the 21st Century

Max Klein (H1 1985-2015)
U Liverpool and CERN

Colloquium at DESY Hamburg - 30th anniversary of the Approval of H1, 5.11.2015

Feynman's Wisdom

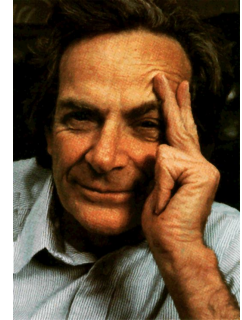

⁹I would like to quote Feynman in a recent interview to the “Omni” magazine: “As long as it looks like the way things are built with wheels within wheels, then you are looking for the innermost wheel - but it might not be that way. in which case you are looking for whatever the hell it is you find!“. In the same interview he remarks “a few years ago I was very sceptical about the gauge theories... I was expecting mist. and now it looks like ridges and valleys after all.”

Cited: Abdus Salam
Nobel Lecture 1979

29th of May 1984

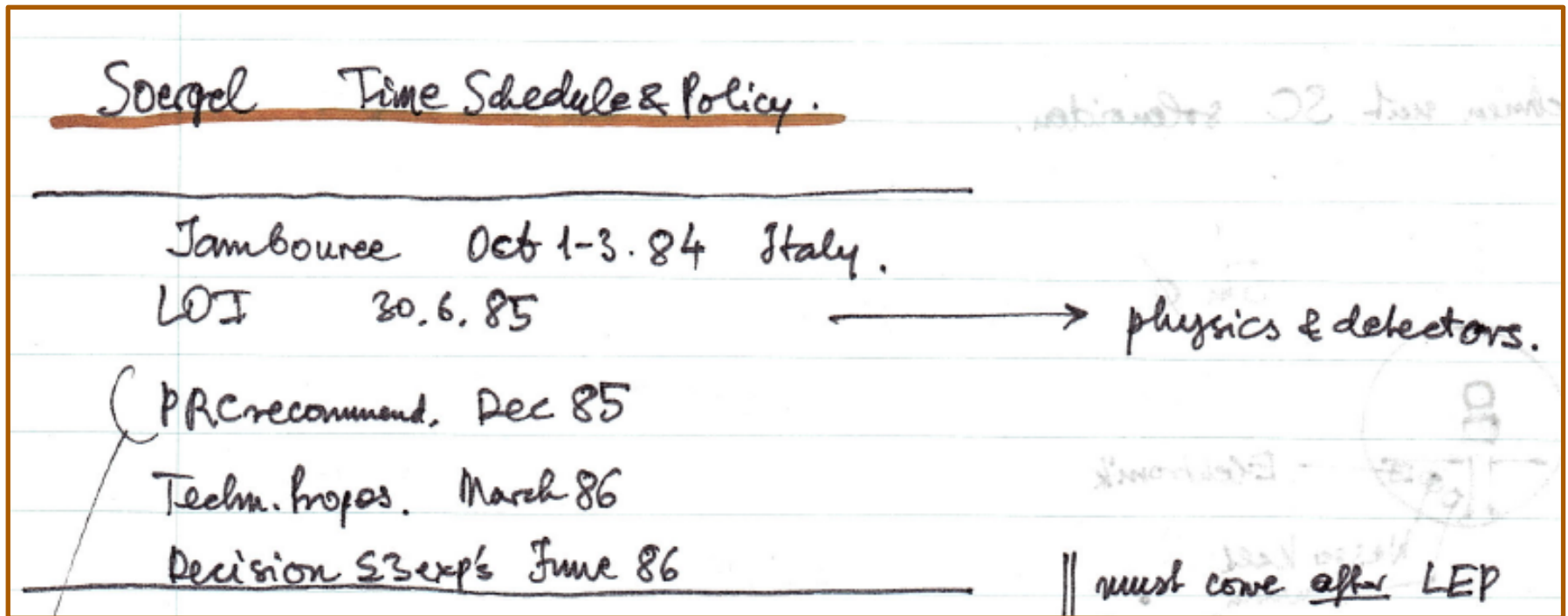

This and subsequent handwritten notes are taken from my logbooks

↑

This is what we celebrate today
Soergel's 84 schedule held to 86
since HERA, H1, ZEUS stuck to it.

Di. 2.10.

Theory

HERA Workshop Genoa Oct 1984

R. Peccei A speculative look forward

$SU_3 \times SU_2 \times U_1$ many questions.

- 1) elementary Higgs $\Lambda_F = \langle \phi \rangle$ then need SUSY due to theoretical consistency
 $[SU_3 \times SU_2 \times U_1 \otimes SUSY]$
- 2) dynamical $SU_2 \times U_1$ breaking $\Lambda_F \approx \Lambda_{TC}$ new strong interaction
 $[G_{TC}]$
- 3) composite q's, l's $\Lambda_F \approx \Lambda_C$ preon bound states
 $[SU_3 \times SU_2 \times U_1 \otimes G_{preon}]$
- 4) composite W's $\Lambda_F \approx m_W$
 $[SU_3 \times U_1 \otimes G_{preon}]$

→ result. Beitrag von HERA: Erklärung, was die Fermi-scale ist!
 theorists can not decide.

// "Theorists only prediction: there will be new physics."



G. Voss. Halls & Interaction Regions.

4 Halls.

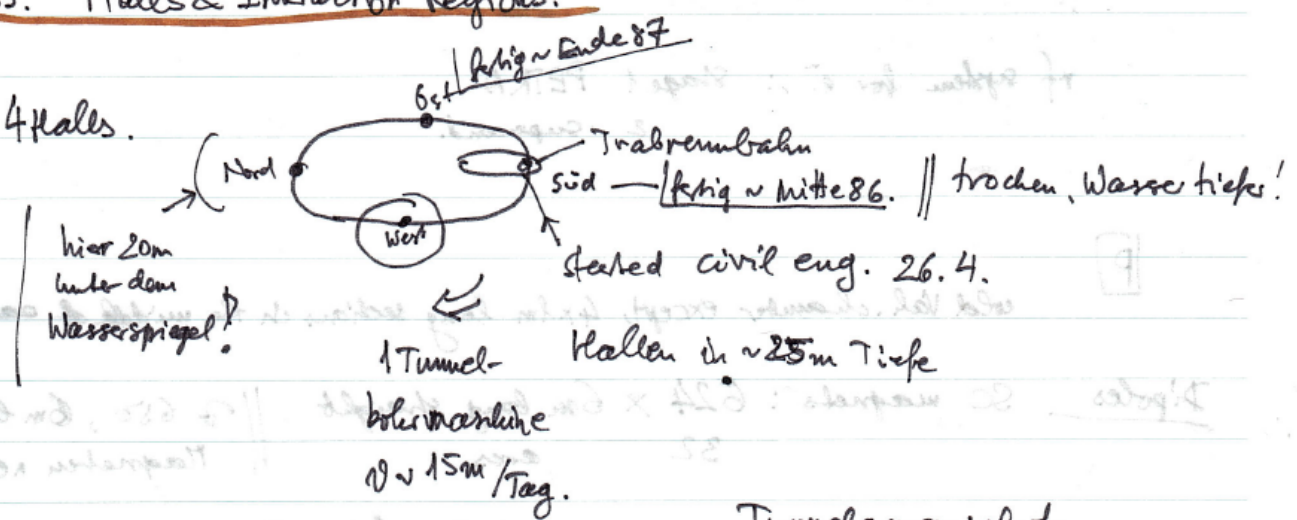

1 Tunnel-
bohrmaschine
Ø ~ 15m / Tag.
Hallen in ~ 25m Tiefe

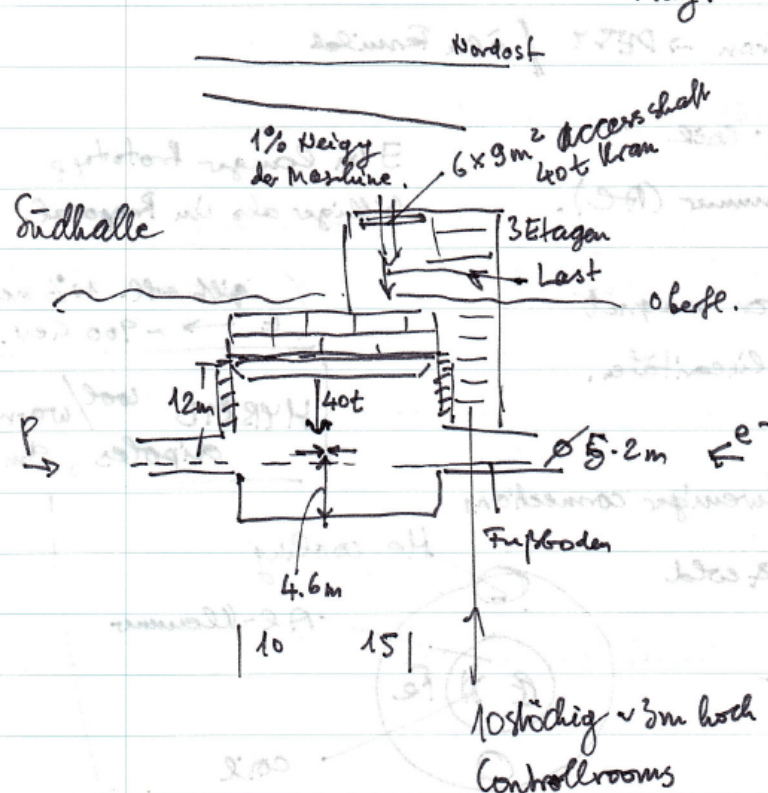

Tunnelgenauigkeiten.
± 20 cm Bögen
± 10 cm Geraden

Stahl hat Neigung ~ 20cm

haben private Firma
engagiert, um optimale
Weg für Kabel zu finden
(Detektor → Controlrooms)

W. Bartel

Head-on collision geometry

Interaction Region

conflict: 1) like to separate e, p over short dist.

loss of L if q 's move out
strong bends

2) " keep synchr. rad. away

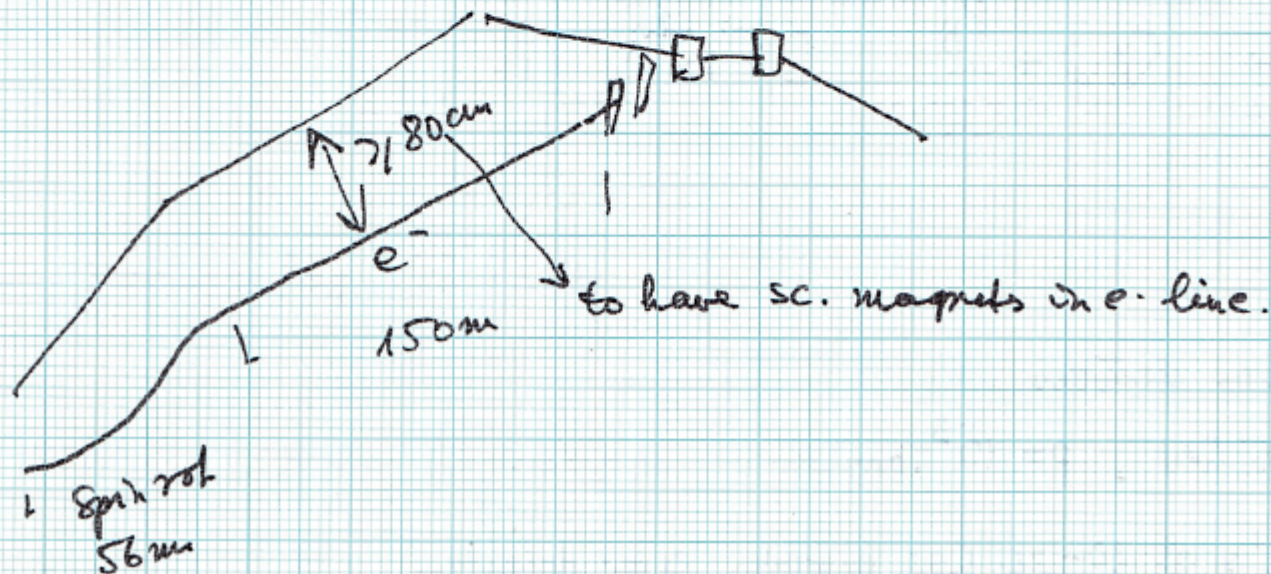
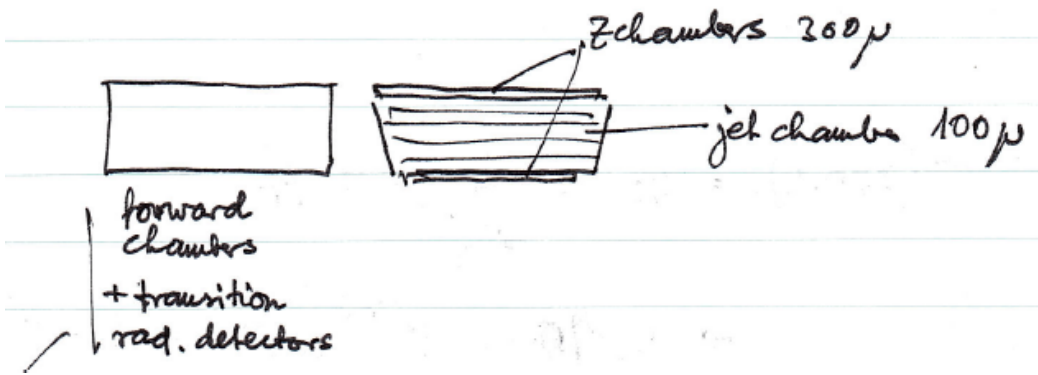

Figure (Düro P. Steffen FN1
Uchlergedropf)

3137

Detector Design

talk by Franz at
 Genoa, 2.10.84



Vorteile von Ar: excellent calibration possibilities
 - intercalibration of different towers
 ↳ small b!

$$\frac{G}{E} = \frac{a}{E} + b$$

no radiation problems
 fine segmentation

Unification - Fall 1990

In the fall 1990 we unify CJC1 with COZ while the two German states unite also – 25 years ago

Date: TUE, 4 SEP 90 16:36:52 MEZ
From: Meissner <H1TMEI@DHHDESY3>
To: <H1KMAX@DHHDESY3>

Hallo Max!



CJC1 und COZ sind vereinigt. Die letzte Stuetzstange wurde soeben aus der CJC1 gezogen. Damit ruht nun die gesamte Last der CJC1-Draehte auf unseren Flanschen. Die Ursache fuer das gestrige Klemmen der Kammern war ein Dichtungsring der CJC1, der aus seiner Sollposition verrutscht war. Bevor die Kammern den Reinraum verlassen, sind noch ein paar Arbeiten zu erledigen: -Gasdichtigkeitstest an der CJC1

-Drahtspannungsmessung an der CJC1

-Umbau des Wagens, der beide Kammern aufnehmen soll

Beim Aufbau der Fuehrungsschienen fuer die Adapterkarten moechte ich dabeisein. Diese Arbeiten sollten wir auch nicht mehr oft wiederholen im Interesse der Vermeidung von Materialschaeden. Ich werde also voraussichtlich am Donnerstag noch nicht in Zeuthen sein koennen.

Viele Gruesse, Achim

Wohl faß ich, was mir
offenbart,

Versteht ist mir, warum
Gott wollte haben,

uns zu lösen, gerade diese
Art

Dante Gött. Komödie
'Paradies'

Detector Preparations

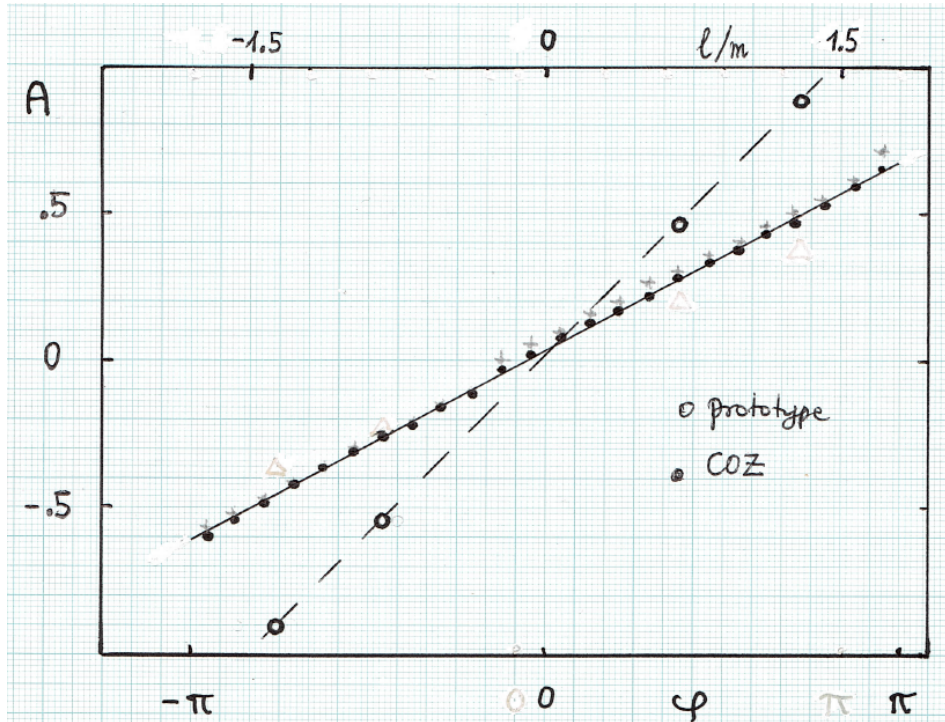

Special thanks to Peter Truoel and PSI for hosting the Zeuthen group for COZ prototype tests

$$A = \frac{Q_L - Q_R}{Q_L + Q_R}$$

prelim.
20.5.90

Ar / Propane

- Stablohm 48 μm ϕ
COZ 0.6 k Ω /m

$$\frac{\delta l}{L} = \frac{b}{2} \delta A$$

- Elgiloy 20 μm ϕ
P3 2.6 k Ω /m

$$\frac{\delta l}{L} \approx 2\% \text{ (raw estimate)}$$

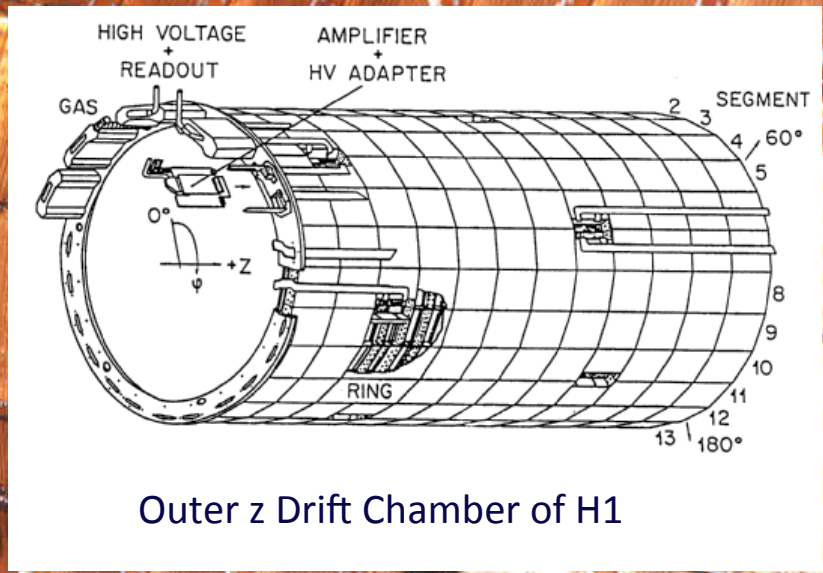
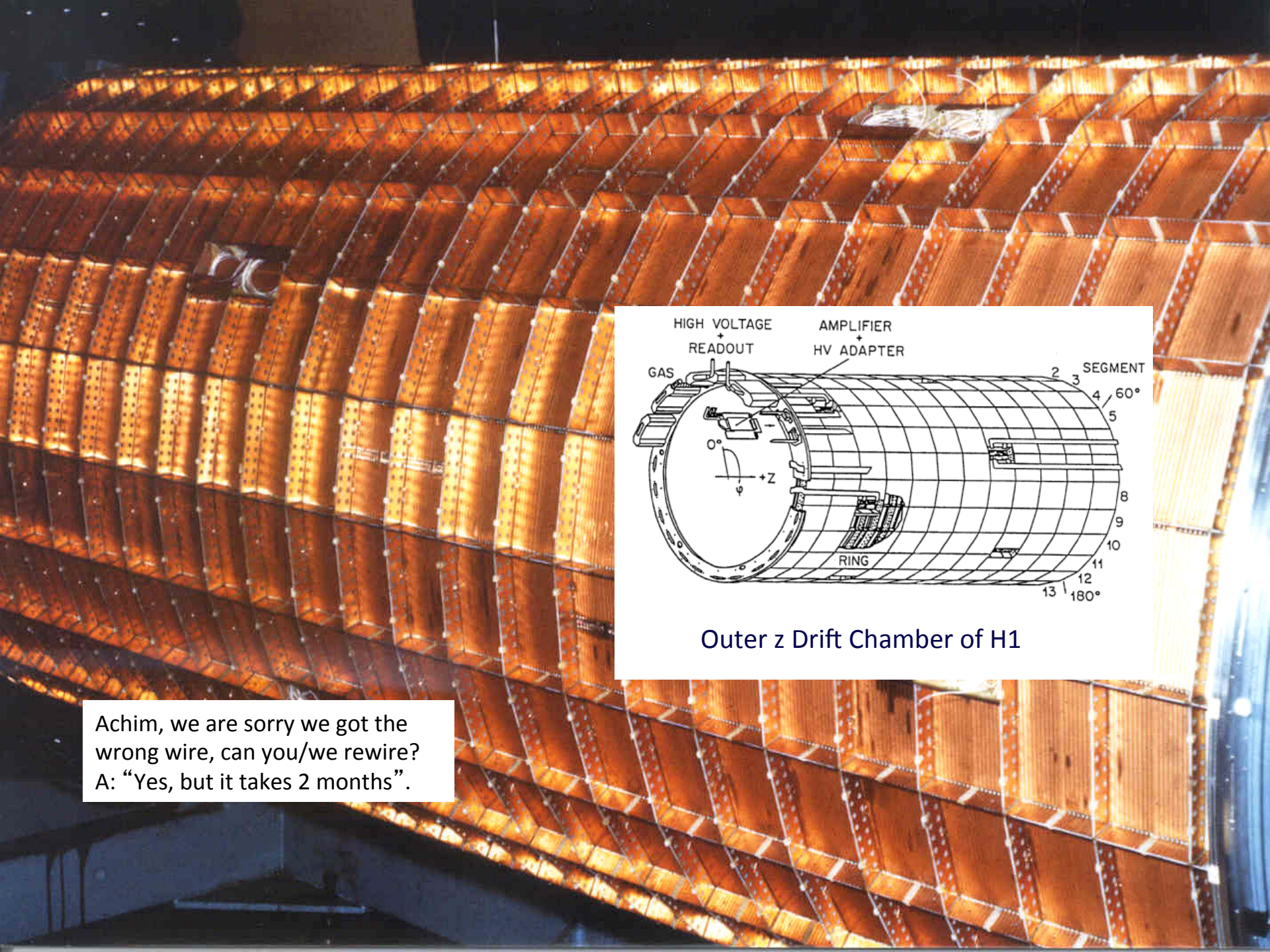

Outer z Drift Chamber of H1

Achim, we are sorry we got the wrong wire, can you/we rewire?
A: "Yes, but it takes 2 months".

TRACKING DETECTORS INSTALLATION

WILL YOU PLEASE INDICATE THE NAMES OF YOUR
GROUP RESPONSIBLES FOR THE FOLLOWING SUB-SYSTEM

DETECTOR COMPONENT CO2

GROUP/INST / Zenith

MECHANICAL COMP. U. Harder

GAS SYSTEM H. Bärwolff

PIPING GAS/WATER J. Meißner / J. Meißner

CABLE LISTING H. Lippold

ELECTRONIC RACKS H. Lippold

HIGH VOLTAGE H. ~~Wipperf~~ Henschel

ASSEMBLY INTEGRATION
AT DESY U. Harder

SAFETY ASPECTS H. Bärwolff

RETURN TO: EDDIE TOWNDRON
ROOM 332 BUILDING 1b
DESY

H1 relied on many
very competent and
dedicated engineers
and physicists!

The burocracy was
tolerable...

H1 in 1990

Plan for the
installation
of the BPC

Date: WED, 14 NOV 90 08:41:56 MEZ
From: Karlheinz Meier <F11MEI@DHHDESY3>
To: Max Klein <H1KMAX@DHHDESY3>
Subject: zeitplan

Karlheinz Meier
DESY - Group FH1K
Notkestrasse 85
D-2000 Hamburg 52
tel -49 40 8998 2028
fax -49 40 8998 3093

Zeitplanung fuer BEMC/BPC Installation

Meeting vom 12/11/1990 bei DESY

Teilnehmer: Brasse, Klein, Leuschner, Levien, Meier, Schirm

Der folgende Zeitplan von heute bis zur Installation/Verkabelung
von BEMC und BPC wurde vereinbart :

Woche 47 - 48 (19/11/90 - 30/11/90)	Cosmic Test der BPC am ZWG
Woche 49 (3/12/90 - 7/11/90)	Transport BPC zum DESY (Montagehalle I. Inst.)
Woche 50 - 51 (10/12/90 - 14/21/90)	Tests BPC
2/ 1/91 - 9/ 1/91	Test Montage BPC/BEMC
10/ 1/91	Transport BEMC und BPC (getrennt !) zur N-Halle
14/ 1/91 - 15/ 1/91	Vermessung und Ausrichtung Grundgestell
16/ 1/91	BEMC Installation
17/ 1/91 - 18/ 01/91	Installation und Verkabelung der BPC auf dem BEMC
21/ 1/91	Einfahren von BEMC/BPC
22/ 1/91 - 28/ 1/91	Verkabelung BEMC (CDA) und Tests BEMC/BPC mit Zugang zur CDA

Norbert Langhoff
28.10.2015 - 80 y
Director of ZWG

The SSC in 1990

Wojcicki : 87 km U

~50 m unterirdisch

SSC

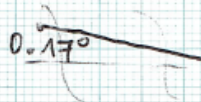

Austria
chalk

Staub ist das Problem
als Wasser.

6.6 T
15.8 m std length
dipole

6.5 kA

Freedman SPC science policy
Sandweiss PAC program advisory.

2.7 kA/mm J_c
NbTi
6 μ m Draht ϕ

4 Jahre Magnetentwicklung
von Fermilab-Magneten.

d Ferrari / Magnet.

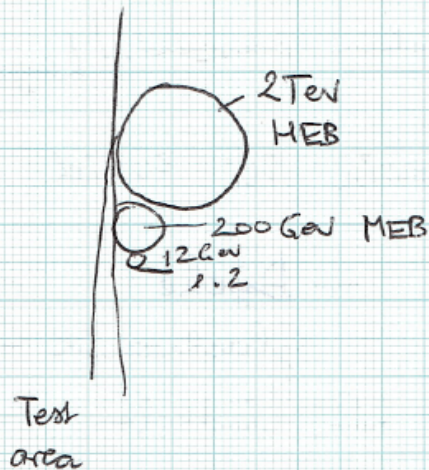

beam-beam tune shift
(head-on and long range)
limits L to $10^{34} \times 2$
at $\sqrt{s} \sim 35$ TeV

nominal
 $L = 1.6 \cdot 10^{33}$ peak.

1.5 events / collision.

The SSC in 1990

June 82 : intellektuelle Geburt
Jan. 87 endorsed by R. Reagan
Dec 88 Texas site chosen
May 90 14 expressions of interest

Nov. 90 recommendations
on EOI's.

1st proposals end of 91
due (tentative)

4 4 π detector

solenoid
toroid calor.
L*

Trilling
Sulak
Ting.

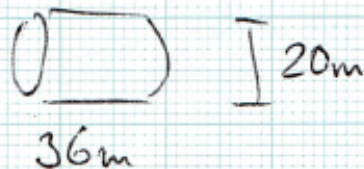

Fort Worth (good old
cowboy town).

Dallas (artificial
Mill Emswiler).

2 high lumi

3 B physics

5 specialized.

A president, 14 Lols, a tunnel, magnets...:
and yet no success – a long term disease

H1 Meeting on Cross-Section Measurement

January 22nd, 9 a.m.- 6 p.m., sem.room 4, DESY

Agenda (preliminary)

1. Final State Deep Inelastic Physics

- MPI

2. Inclusive E and Θ Measurements - Resolution, Calibration, Efficiency

- P.Schacht: jet energy

- J.Ferencei: electron energy

- S.Maxfield/T.Naumann: Θ and p measurement with the tracking detectors

3. Measurement of Q^2 and x

- G.Bernardi: (Q^2 , x) resolution with hadrons

- J.Blümlein: cross calibration of e and jet measurements

- E.Binder: estimation of smearing correction with PSI (e and h)

4. Event Selection

- M.Goldberg: separation of NC/CC

- L.Wormsley: e/π separation

- N.Huot, S.Levonian: photoproduction background

5. Luminosity and Trigger

- S.Levonian: accuracy of luminosity measurement

- U.Straumann: dead-time corrections

- A.deRoeck: triggers on inclusive DIS (efficiency and redundancy)

6. Requirements from Electroweak Physics on Cross Section Analysis

- D.Haidt

7. Radiative Corrections

- W.Krasny: experimental control of radiative corrections

- T.Riemann: uncertainties of NC and CC rad.corr. calculations

8. Discussion of Procedures to Derive the Inclusive Cross Sections

- W.Krasny: iteration procedures

- M.Klein: xsection measurement in BCDMS

...

More physics oriented talks (parton distributions, R measurement, running strategies, cross section analysis ...) will be left to the HERA workshop or/and other times.

HERA moves on to prepare its physics

Date: WED, 31 OCT 90 15:38:46 MEZ
From: <F11EIS@DHHDESY3>
To: Max Klein <H1KMAX@DHHDESY3>
Subject: MAIL from F11EIS at DHHDESY3

Franz Eisele DESY-FH1K
H1 Collaboration DESY, spokesman
Notkestrasse 85, D 2000 Hamburg 52, Germany
Tel. (040) 8998-3086 (secretary ext. 3144/3015)

attached a proposal for convenors for the new HERA working groups.
I hope that you will be able to accept this task.

c

H1- convenors for the HERA working groups (joined effort with
theory and ZEUS) F. Eisele

c
The following people have been nominated by the executive committee:

- WG1: structure functions: Max Klein, Zeuthen (at DESY)
 - WG2: QCD at low x: J. Feltesse Saclay (at DESY)
 - WG3: radiative corrections W. Krasny, Saclay (frequently at DESY)
 - WG4: electroweak physics: D. Haidt, DESY
 - WG5: photoproduction: S. Levonian, Lebedev Inst. Moscow (at DESY
from nov. 15. 1990)
 - WG6: heavy quarks: P. Truoel, Univ. Zuerich
 - WG7: Jets and hadronic final states: K.H. Meier, DESY
 - WG8: _____
 - WG9: beyond standard model: Ch. Berger, Aachen
- generators: G. Grindhammer, MPI Munich (at DESY)
- c



CB. 13.12.1990

Sveergel

may: polarization studies, SC cavities installed

TRISTAN has λ
LEP too

good polarization and λ seem
to exclude each other. | Hermes may run dedicated.

PRC has recommended to approve HERMES, if dedicated don't give them
directorate: accept HERMES after more than 10%
demonstration of λ (not before
end of June).

$\lambda_{\perp} \sim 60\%$ min

rotation diminishes
 λ bei 10-15%

rolling in only after
Ep up and backgrounds
understood
1st of August

maintaining of the
DESY budget is
not likely
| new budget not before
Easte

4 wire OR μ trigger (4T)
for μ 's (J, W, b...)

may be new gästehaus
starting in 91

find another group for Queen Mary.
Aachen I+III

upgrade: Si drive in, ^{H1} must
accept new collaborators

relative priorities in funding must
be decided on.

expects TP until spring 92.

CO2 muß gehen!!



Backward Upgrade – Calorimeter - 1991

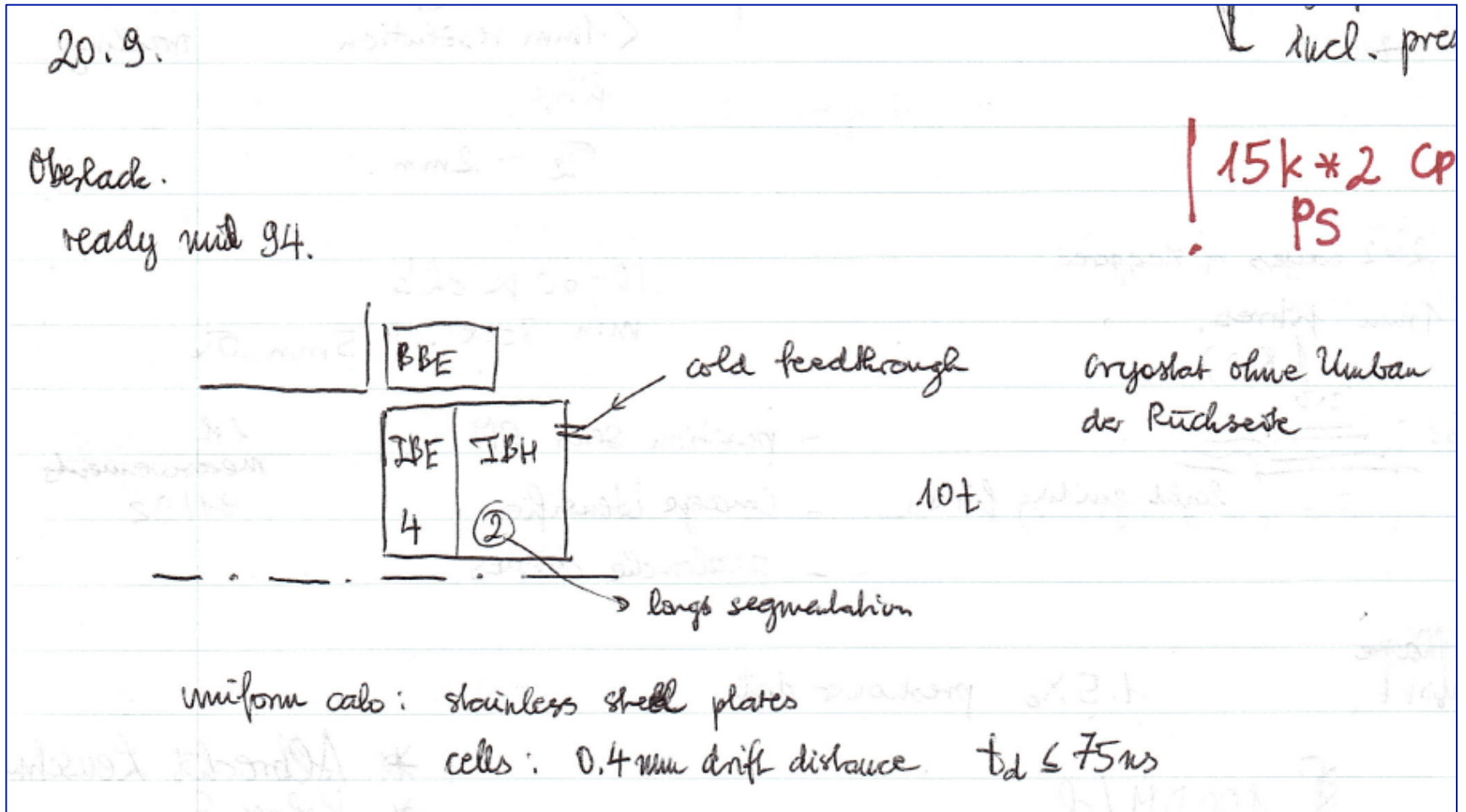

H1 CB decided for Spacal

HERA workshop.

29/30. 10. 1991

deadline for proceedings
6. 1. 1992

out 1.3.92

Wick : lowest L ever recorded.

$\therefore 3.7 \cdot 10^{10} e^{\pm} / \text{bunch}$ in 210 bunches 96 ns apart 58 mA
 $10^{11} p / \text{bunch}$ " " "

19. 10. 91, 18⁵⁰ 1st ep collisions.

$$12 E_e \times 480 E_p$$
$$1.03 \cdot 10^{26} \pm 13\% \text{ cm}^{-2} \text{ s}^{-1}$$

useful L late spring.

HERA works !

Moriond 1993

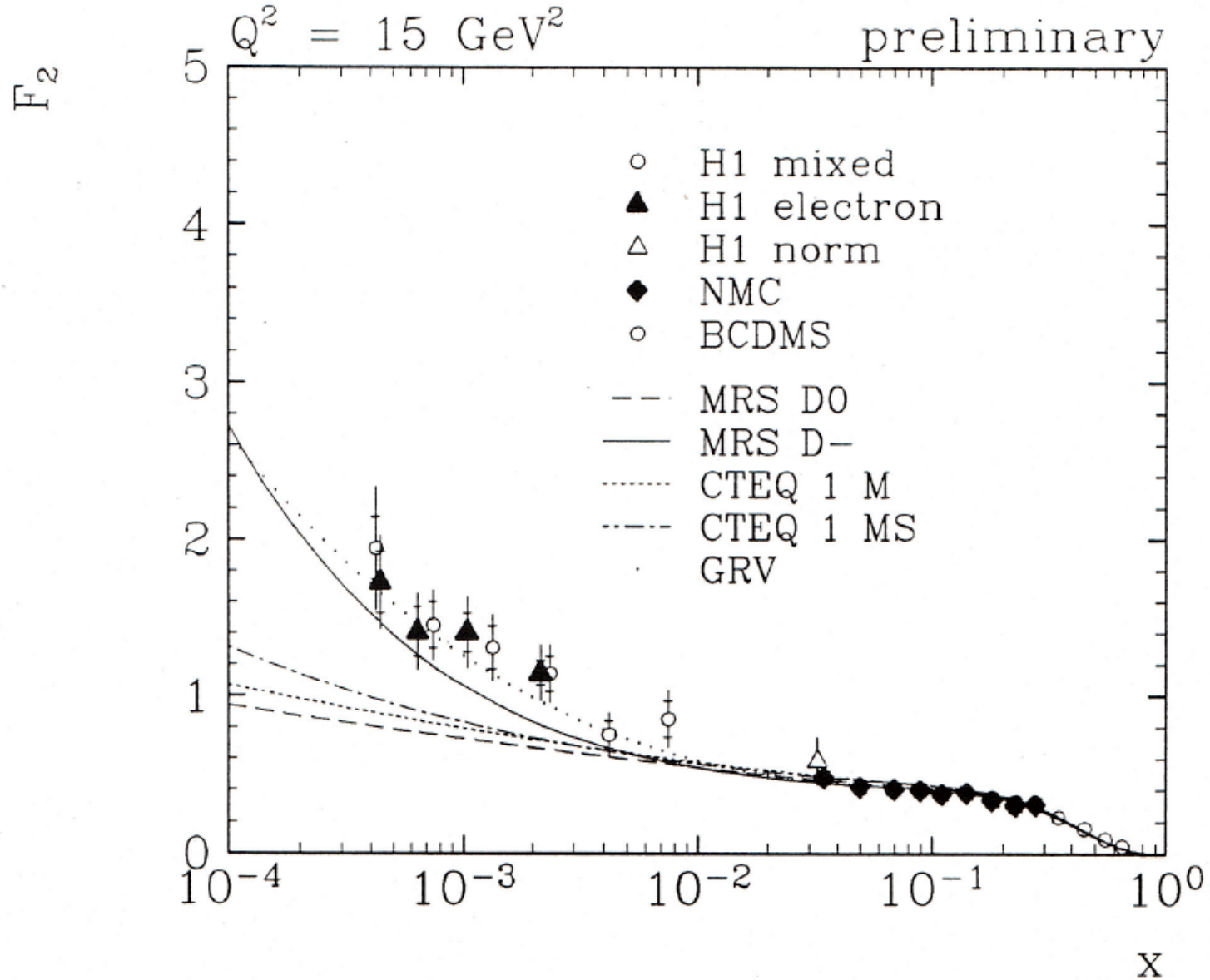

Moriond 1993

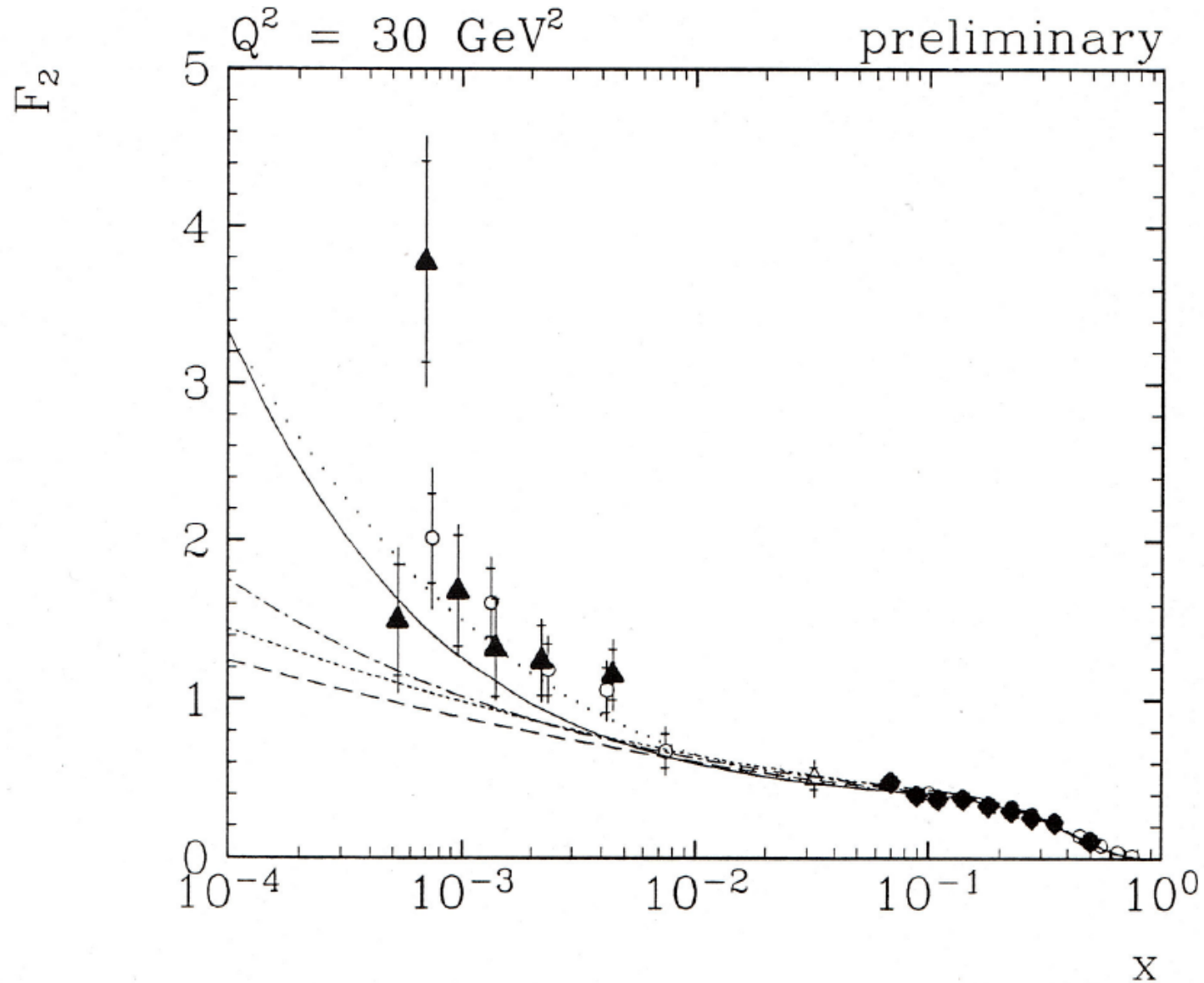

Moniod.

KVARIABLE=1 EE 2 EM				1											
KBINNING=1 QX 2 QY				1											
Q2= 7.5000000															
X	FT	+ST	+SY	D0	D-	R	NEV	ACC	SXY	RCO	BSC	KAP	Y	EFVTX	
MODE : 47 , for MRS Set D- (L215) Structure Functions															
0.00024	1.54	0.14	0.28	0.65	1.55	0.61	124	0.560.487E+06	0.15	0.836		13268.1	0.3611	0.900	
0.00042	1.00	0.11	0.13	0.62	1.23	0.57	79	0.570.375E+06	0.14	0.616		8902.6	0.2032	0.990	
0.00075	0.95	0.13	0.20	0.60	0.99	0.53	54	0.480.399E+06	0.16	0.490		5499.5	0.1142	0.950	
0.00133	0.65	0.12	0.07	0.58	0.82	0.48	28	0.410.275E+06	0.12	0.414		3253.9	0.0642	0.990	
Q2= 15.0000000															
X	FT	+ST	+SY	D0	D-	R	NEV	ACC	SXY	RCO	BSC	KAP	Y	EFVTX	
0.00042	1.64	0.16	0.29	0.81	1.55	0.43	106	0.820.125E+06	0.15	1.069		1789.8	0.4064	0.800	
0.00075	1.52	0.13	0.20	0.76	1.23	0.41	136	0.780.140E+06	0.15	1.094		1220.5	0.2285	0.940	
0.00133	1.00	0.10	0.16	0.71	1.00	0.38	97	0.800.102E+06	0.14	1.089		761.8	0.1284	0.900	
0.00237	0.90	0.10	0.17	0.67	0.82	0.34	74	0.710.945E+05	0.11	0.923		454.0	0.0722	0.990	
Q2= 30.0000000															
X	FT	+ST	+SY	D0	D-	R	NEV	ACC	SXY	RCO	BSC	KAP	Y	EFVTX	
0.00075	1.90	0.23	0.31	0.94	1.47	0.33	71	0.880.350E+05	0.17	1.022		240.0	0.4569	0.930	
0.00133	1.18	0.15	0.18	0.86	1.18	0.31	58	0.890.262E+05	0.14	1.104		166.7	0.2568	0.930	
0.00237	1.30	0.16	0.19	0.78	0.95	0.29	66	0.900.325E+05	0.14	1.099		105.4	0.1444	0.850	
0.00421	0.89	0.13	0.21	0.71	0.79	0.26	49	0.870.229E+05	0.10	1.027		63.3	0.0813	0.990	
Q2= 60.0000000															
X	FT	+ST	+SY	D0	D-	R	NEV	ACC	SXY	RCO	BSC	KAP	Y	EFVTX	
0.00133	0.00	0.13	0.21	1.00	1.35	0.26	28	0.710.229E+05	0.17	1.620		32.1	0.5135	0.000	
0.00237	1.28	0.23	0.15	0.90	1.08	0.24	31	0.870.691E+04	0.14	1.112		22.7	0.2889	0.960	
0.00421	1.07	0.20	0.15	0.80	0.88	0.22	30	0.870.650E+04	0.13	1.106		14.6	0.1626	0.990	
0.00750	1.19	0.19	0.28	0.72	0.74	0.20	39	1.090.752E+04	0.09	1.090		8.8	0.0914	0.900	

→ 1042 events in the first F_2

The rising gluon

Look, ^{this is} $xg(x, Q^2)$

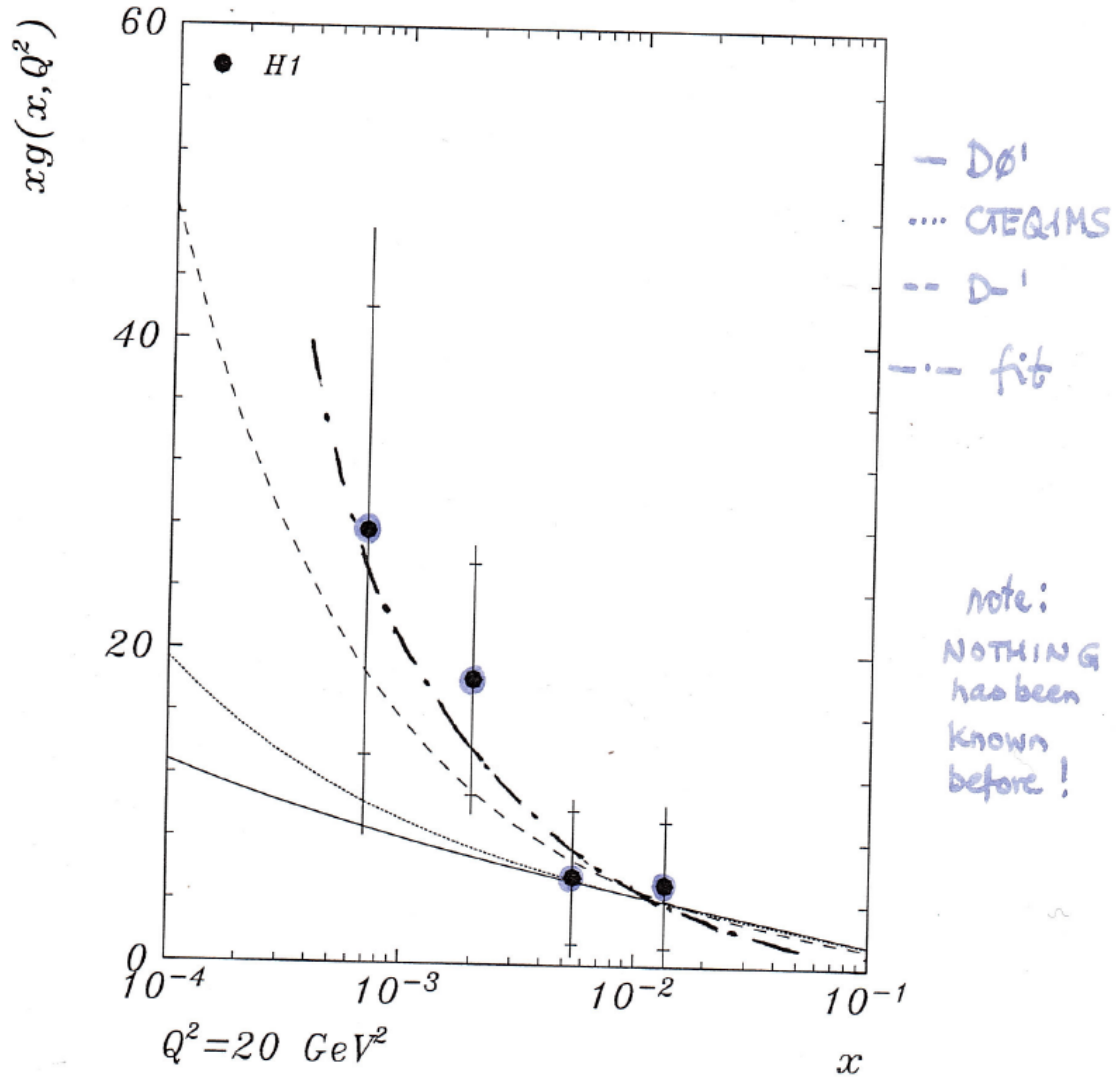

Gluons and Quarks 1989 → 2015

BCDMS

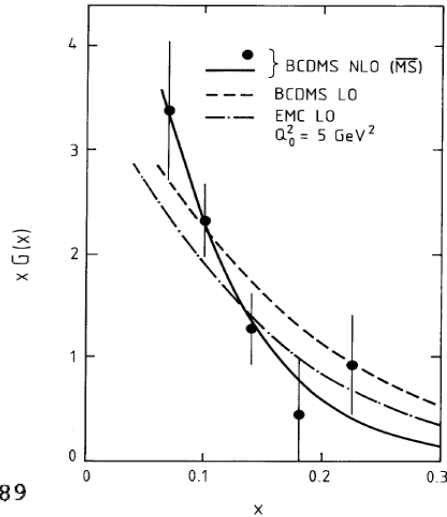

CERN-EP/89-07
January 17th, 1989

fixed target IN to ep collider →

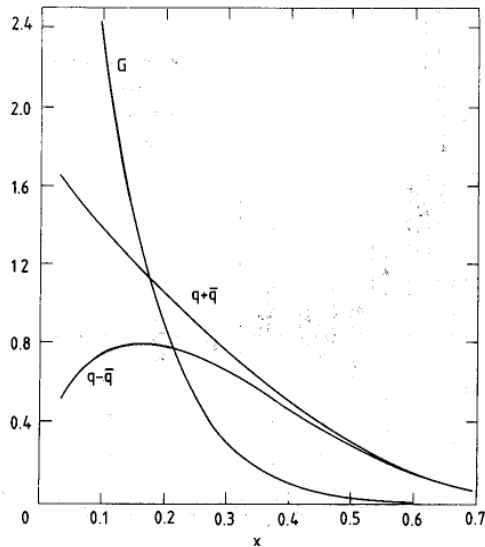

CDHS

CERN-EP/89-103
15 August 1989

H1 and ZEUS

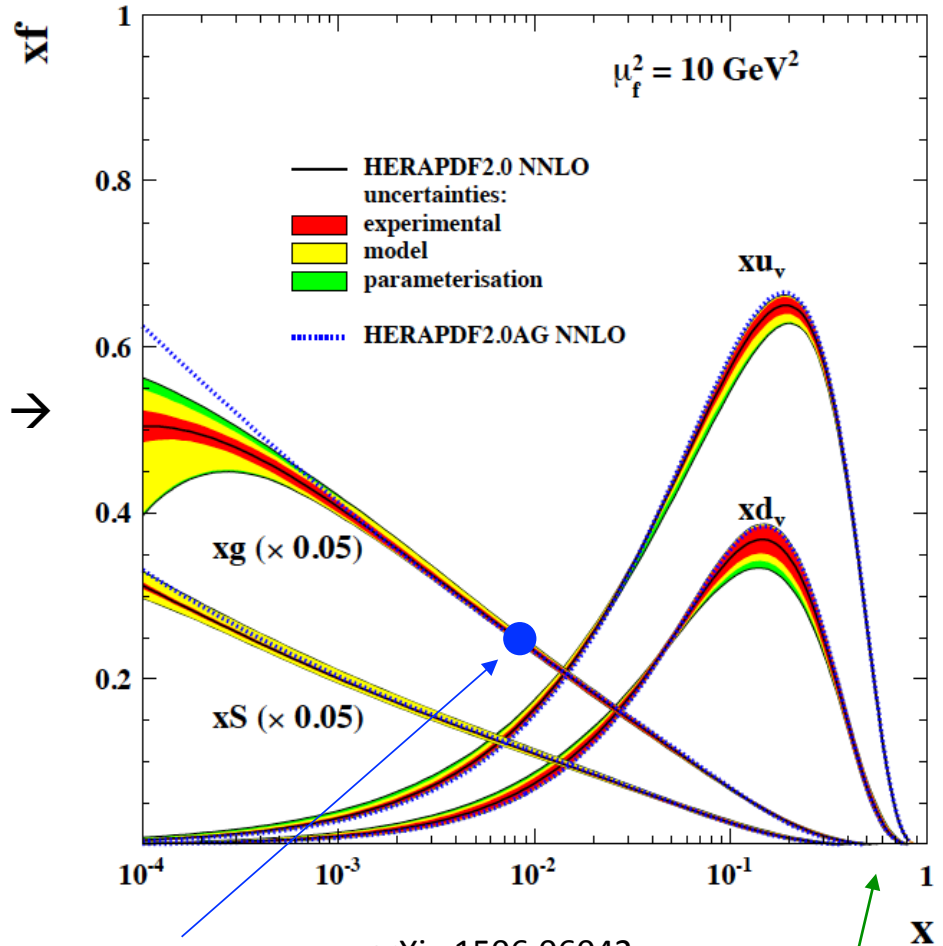

$gg \rightarrow H$
($y=0$)

arXiv:1506.06042
"Legacy" paper NC/CC
HERAPDF2.0 NNLO

High mass
HL-LHC

After Moriond 1993

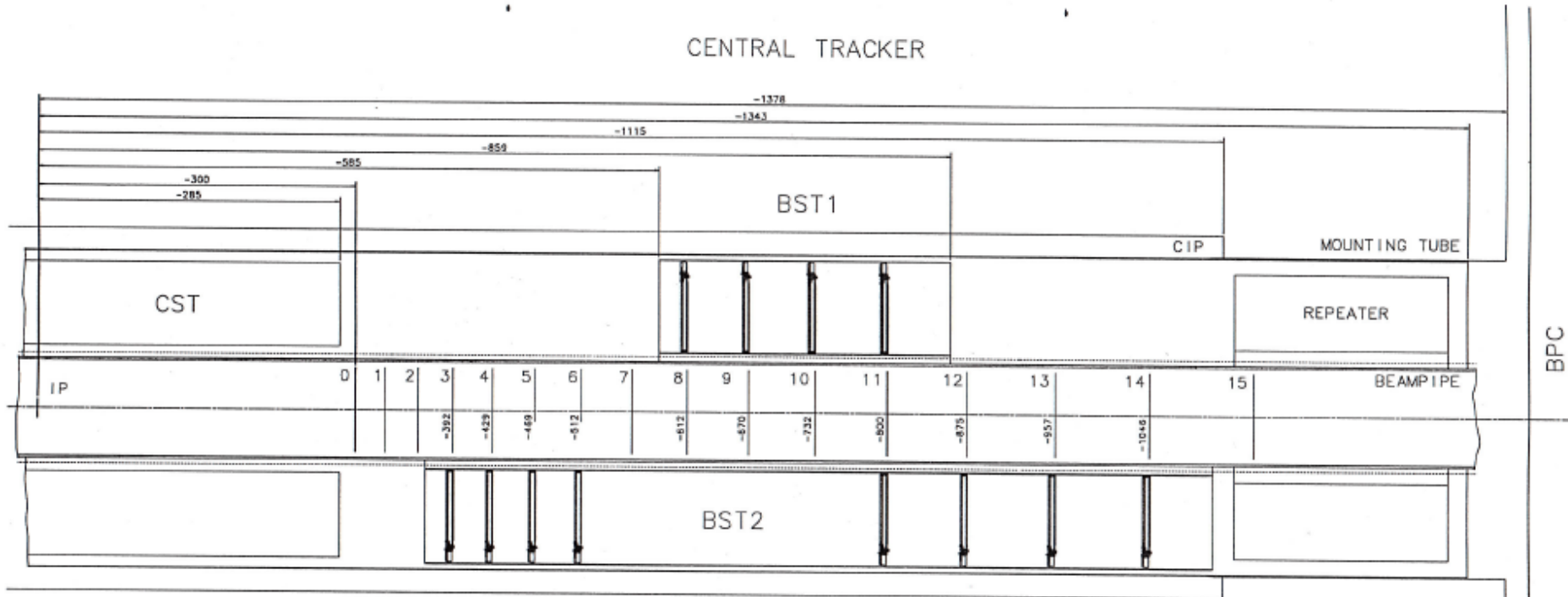

Aenderung
 Die BST-Ebenen werden mit Null
 beginnend nummeriert (entgegen dem
 Technical Proposal).

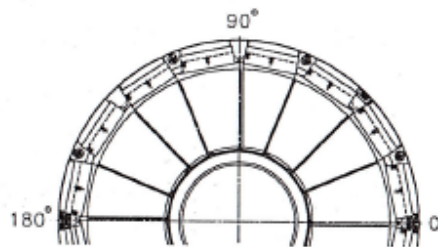

H1-UPGRADE
 CROSSECT ION
 18.5.93 J.Meissner

The four most frequently cited publications of the H1 Collaboration

Deep inelastic inclusive e p scattering at low x and a determination of $\alpha(s)$

H1 Collaboration (C. Adloff *et al.*). Dec 2000. 68 pp.

Published in *Eur.Phys.J.* **C21** (2001) 33-61

DESY-00-181

DOI: [10.1007/s100520100720](https://doi.org/10.1007/s100520100720)

e-Print: [hep-ex/0012053](https://arxiv.org/abs/hep-ex/0012053) | [PDF](#)

[Cited by 629 records](#) 500+

A Measurement and QCD analysis of the proton structure function $f_2(x, Q^2)$ at HERA

H1 Collaboration (S. Aid *et al.*). Mar 1996. 35 pp.

Published in *Nucl.Phys.* **B470** (1996) 3-40

DESY-96-039

DOI: [10.1016/0550-3213\(96\)00211-8](https://doi.org/10.1016/0550-3213(96)00211-8)

e-Print: [hep-ex/9603004](https://arxiv.org/abs/hep-ex/9603004) | [PDF](#)

[Cited by 510 records](#) 500+

Measurement of the proton structure function $F_2(x, Q^2)$ in the low x region at HERA

H1 Collaboration (I. Abt *et al.*). Aug 1993. 20 pp.

Published in *Nucl.Phys.* **B407** (1993) 515-538

DESY-93-117

DOI: [10.1016/0550-3213\(93\)90090-C](https://doi.org/10.1016/0550-3213(93)90090-C)

[Cited by 430 records](#) 250+

A Measurement of the proton structure function $f_2(x, Q^2)$

H1 Collaboration (T. Ahmed *et al.*). Jan 1995. 32 pp.

Published in *Nucl.Phys.* **B439** (1995) 471-502

DESY-95-006

DOI: [10.1016/0550-3213\(95\)98236-U](https://doi.org/10.1016/0550-3213(95)98236-U)

e-Print: [hep-ex/9503001](https://arxiv.org/abs/hep-ex/9503001) | [PDF](#)

[Cited by 330 records](#) 250+



F₂ (1992+93)



F₂ (1994 + 2000)

The famous 4 papers belong to all of H1. I had the privilege to co-write all, and in coming to low Q² work with a most remarkable guard of young students, including also others who are not shown. and also well known colleagues.



F₂(1996/97)

SM Higgs in ep

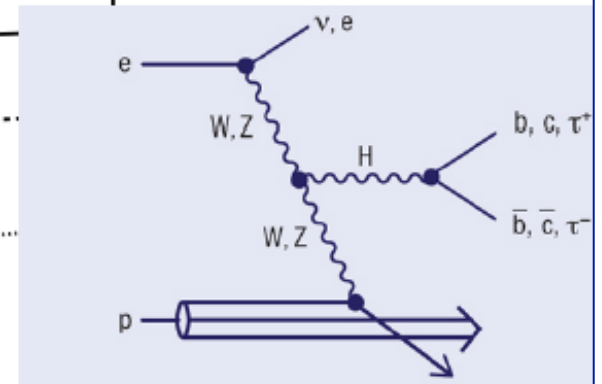
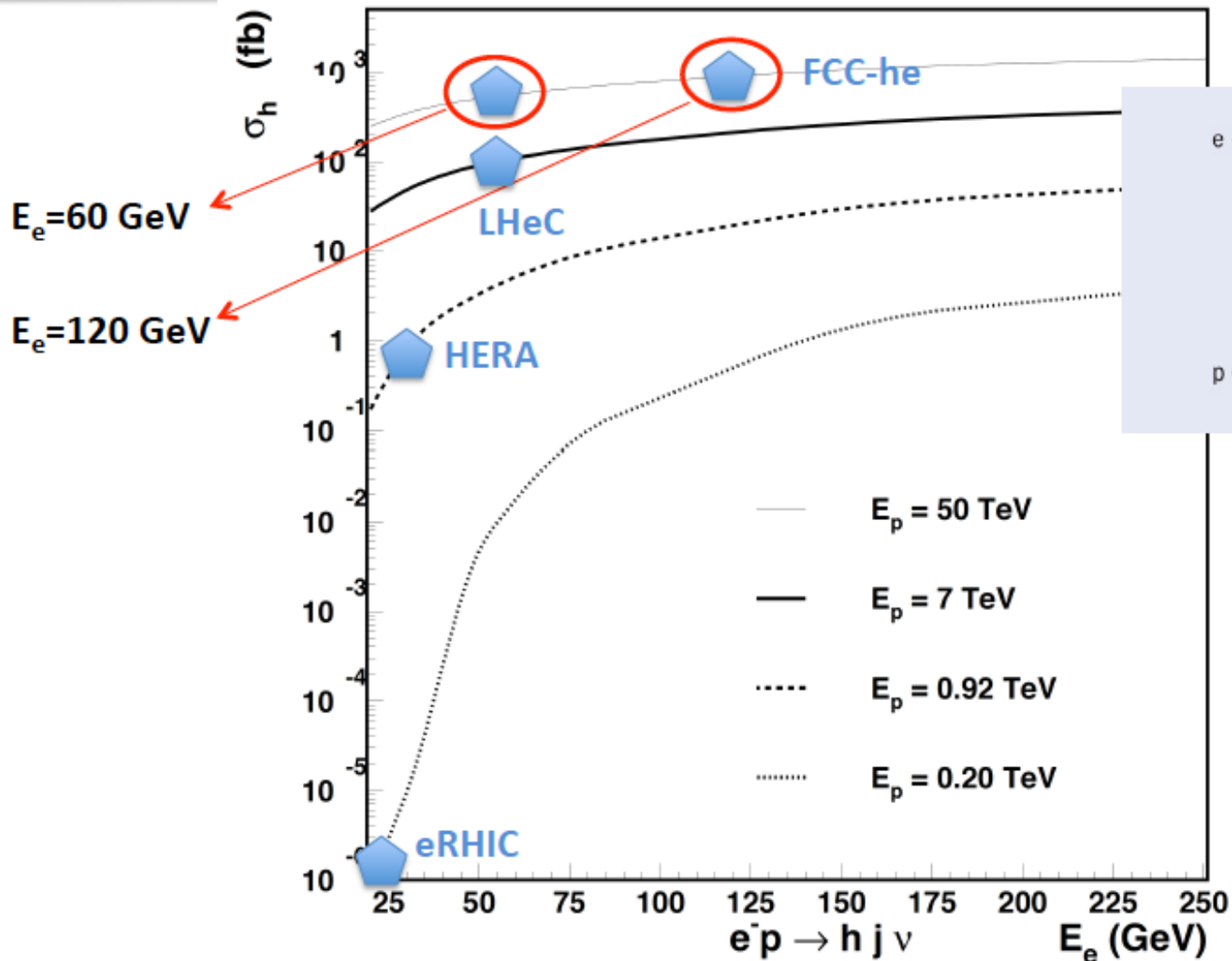

We missed 1000 times luminosity to discover the Higgs at HERA -MK

LHeC / FCC-he: Sizeable charged current DIS unpolarised ep cross sections





Max Klein H1-30

(some of [my]) **HERAs HEROs**



17.2.1937-26.2.1999

A. Febel, H. Gerke, M. Tigner, H. Wiedemann, and B. Wiik, *The proposed desy proton-electron colliding beam experiment. (talk)*, IEEE Trans.Nucl.Sci. 20 (1973) 782-785.

B. Wiik et al., *PROPER - ep with PETRA*, DESY preprint 38 (1977).

J. R. Ellis, B. Wiik, and K. Hubner, *CHEEP: An e-p Facility in the SPS*, CERN Yellow Report NN (1978).

(some of) HERAs HEROs



Sincere thanks to all of H1 – for many of us a lifetime experience of lasting value

LHC Electron Beam Upgrade

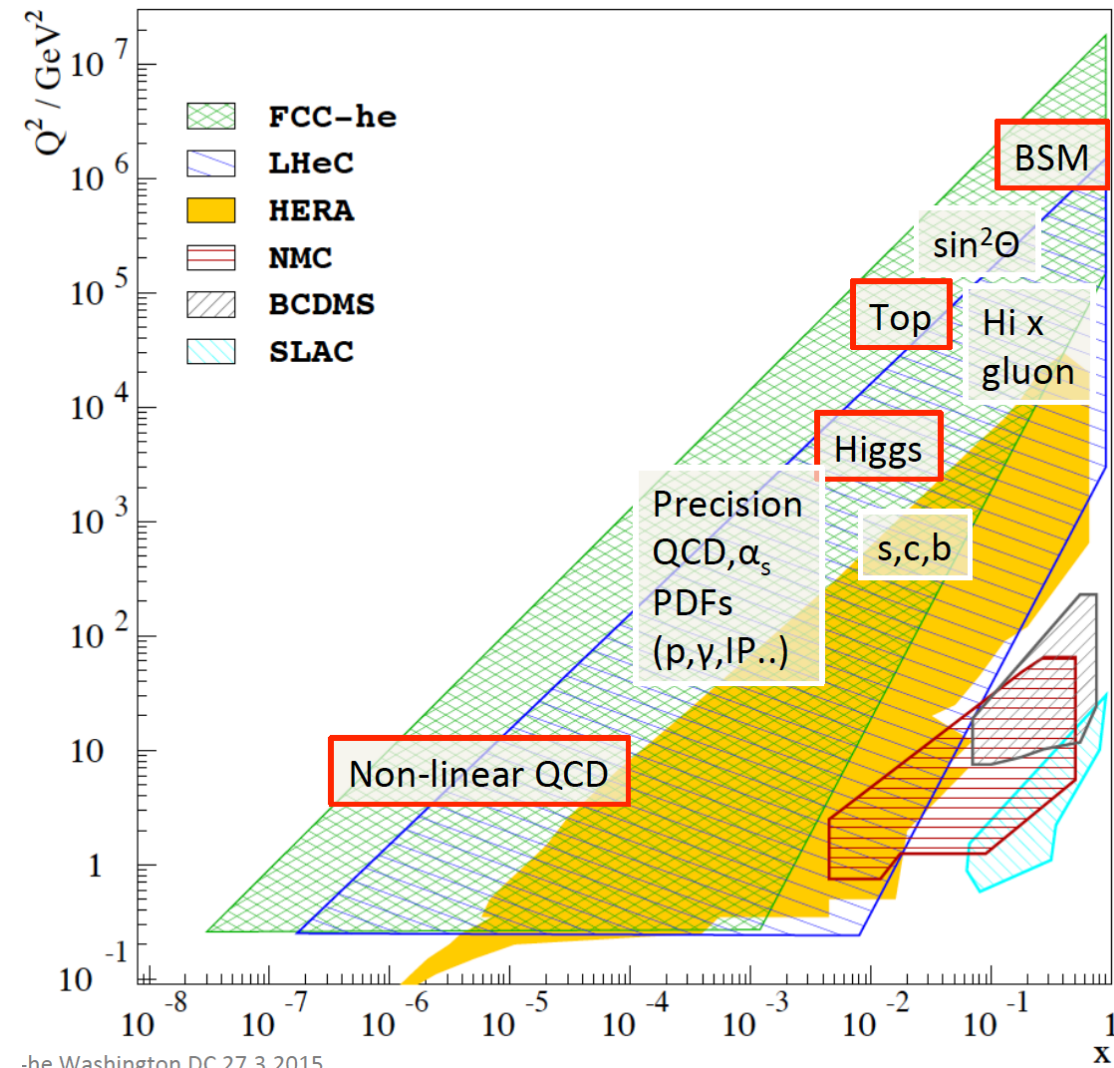

**Luminosity of order $10^{34} \text{cm}^{-2} \text{s}^{-1}$
in concurrent ep-pp operation**

LHeC

- Finest microscope of the world
- The next machine which sees H
- Transforms LHC in precision lab.
- PDFs gain O(.5)TeV search range
- Revolution of nuclear structure

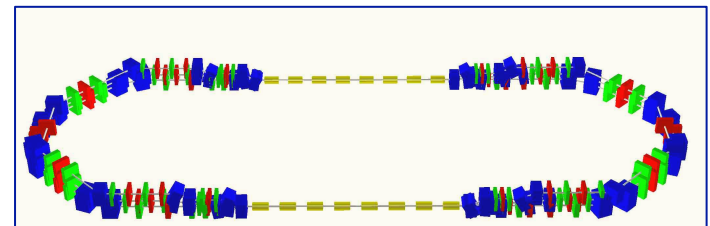

ERL Facility:

Two LINACS 150 MeV, 3 passes
with energy recovery \rightarrow 900MeV

Design Concept 2015

AsTEC, BINP, CERN, Jlab +
scRF, ERL, Physics, Tests

Higgs in $ep \rightarrow \nu H X$

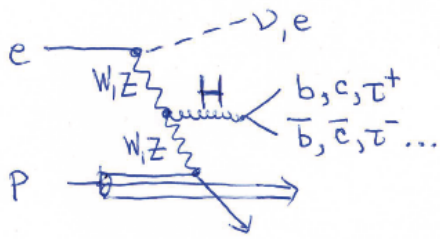

Simulation of $H \rightarrow bb$ Measurement at the LHeC, 100fb^{-1}

$ep \rightarrow \nu H(bb)X$
 charged currents
 $\sigma_{BR} \sim 120 \text{ fb}$
 $\mu = 0.1$
 $S/B \sim 1-2$
 Cut based only

[LHC: VH - BDT's
 $\sigma(VH) \sim 130\text{fb}$ 8 TeV
 arXiv:1409.6212]

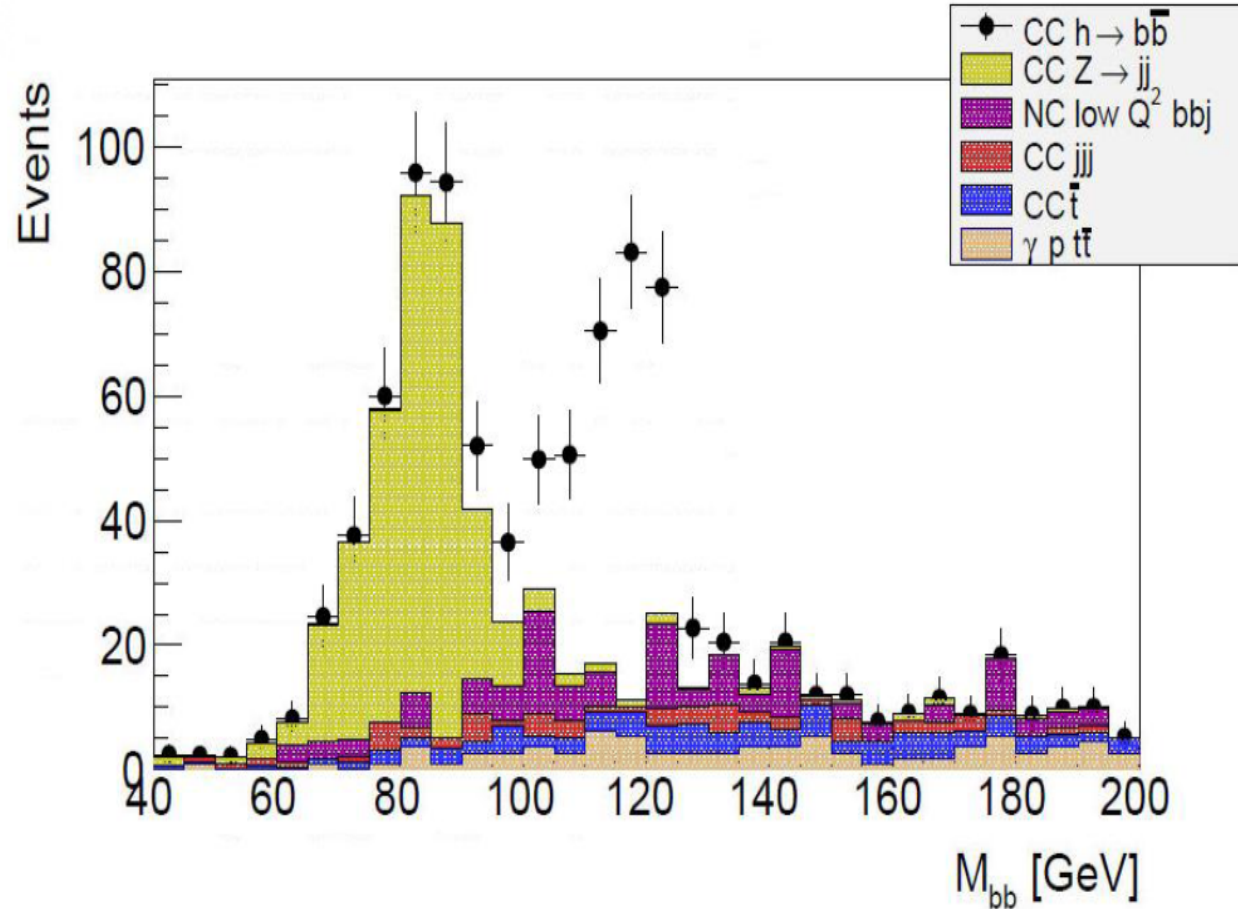

LHeC Higgs Group U.Klein et al.

This reconstructs 60% of H in ep with very comfortable $S/B \sim 1$, in CC and NC
 $\rightarrow O(1)\%$ precision on H- bb couplings with matching theoretical uncertainty]

Civil Engineering Footprint

LHeC construction planning	YEAR 1	YEAR 2	YEAR 3	YEAR 4	YEAR 5	YEAR 6	YEAR 7
Land negotiations	Red	Red					
Environmental Impact Study		Green	Green				
Building permits			Blue				
Detailed design & tendering		Orange	Yellow				
Construction				Brown	Brown	Brown	Brown

7 years for 9km
Civil Engineering

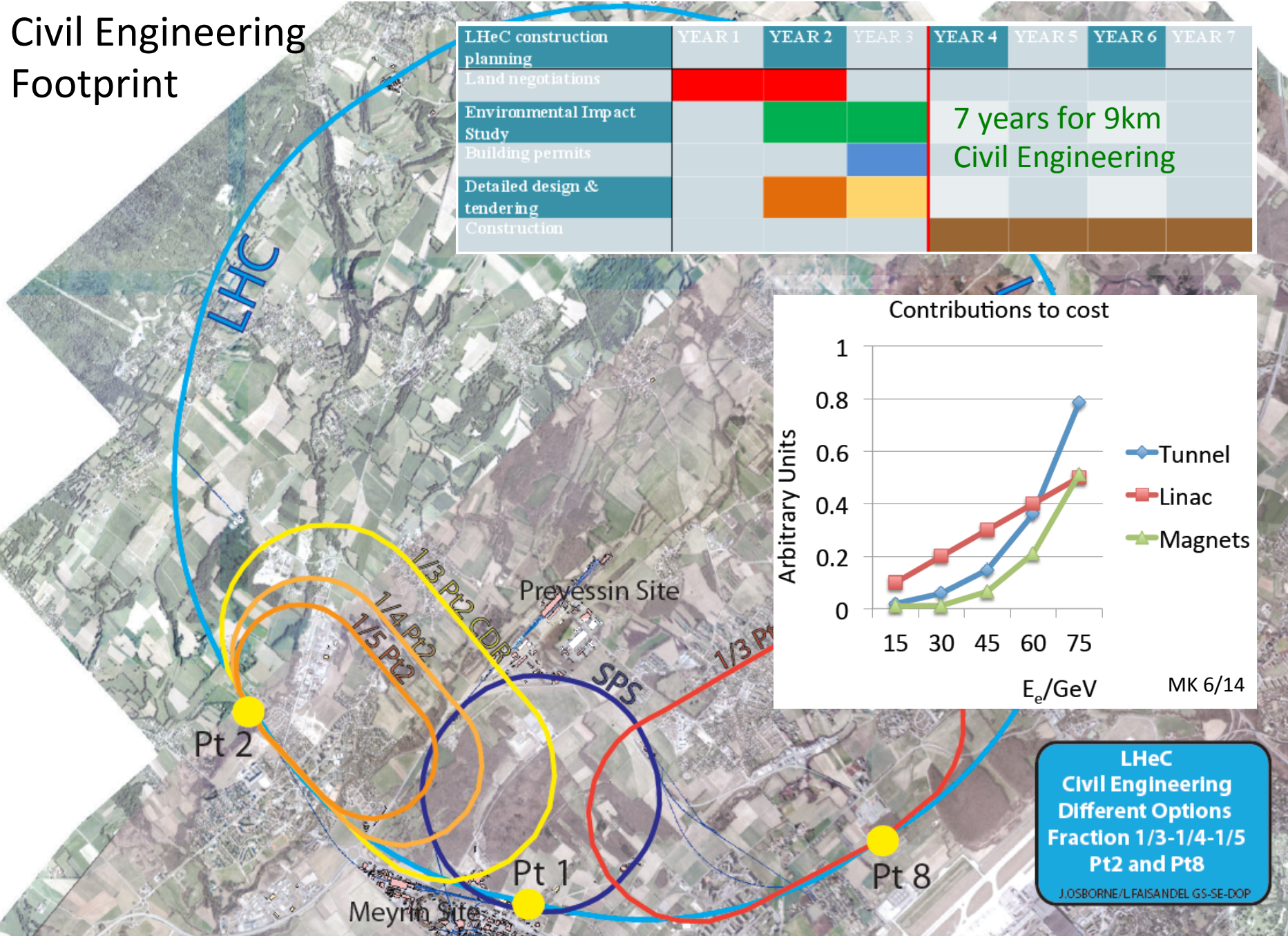
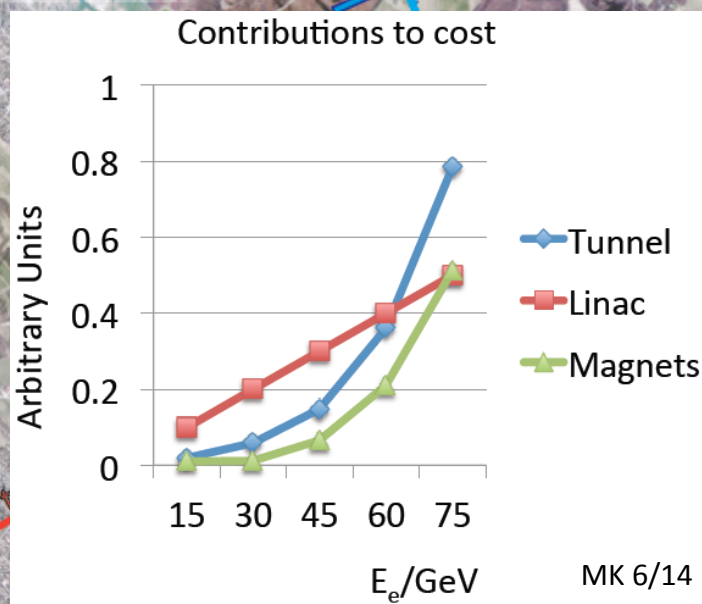

**LHeC
Civil Engineering
Different Options
Fraction 1/3-1/4-1/5
Pt2 and Pt8**

J.OSBORNE/L.FAISANDEL.GS-SE-DOP

Detector description.

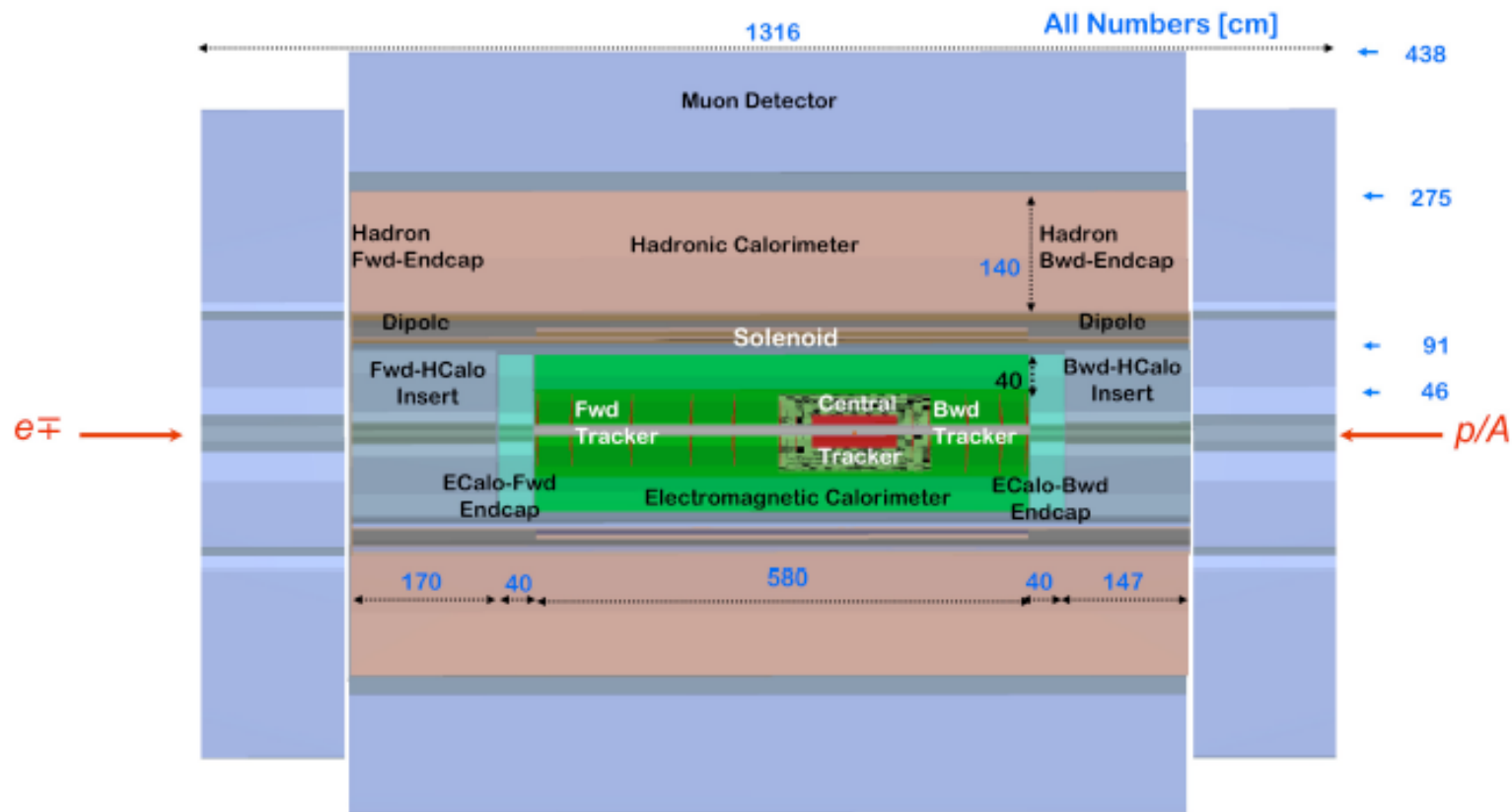

- Forward / backward asymmetry reflecting beam energies (870mm offset)
- Dipole for head-on e-p collisions and central solenoid in common cryostat
- Eta coverage = from -4.5 (backward) to 5.1 (forward)
- Present size 14m x 9m (c.f. CMS 21m x 15m, ATLAS 45m x 25m)

Lepton-Proton Scattering Facilities

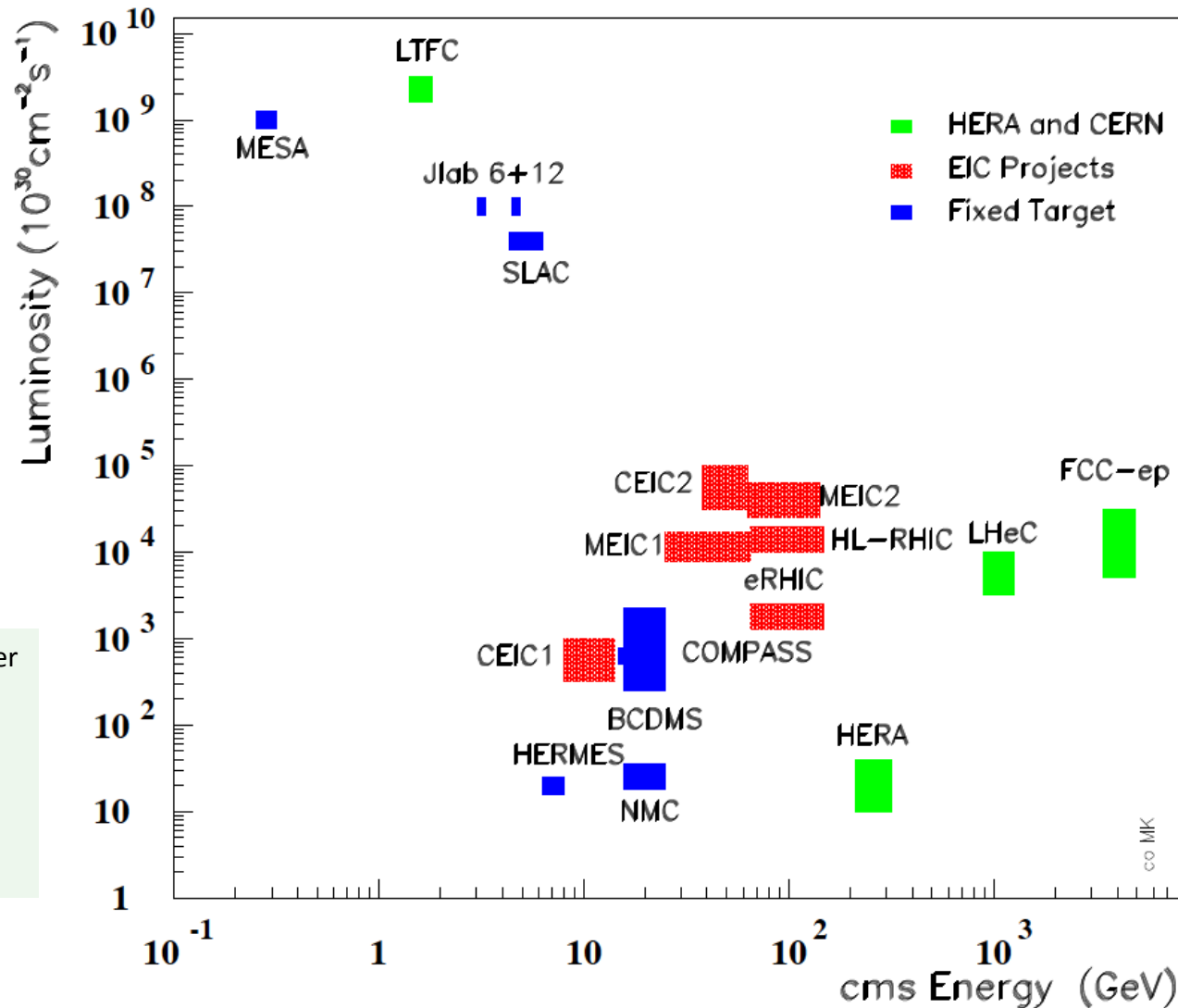

From CERN Courier
MK, H.Schopper
June 2014

With input from
A.Hutton, R.Ent,
F.Maas, T.Rosner

**CERN: LHC+FCC: the only realistic opportunity for energy frontier deep inelastic scattering
Huge step in energy ($Q^2, 1/x$) and 2-3 orders of magnitude higher luminosity than HERA**

backup

H1 in 1990

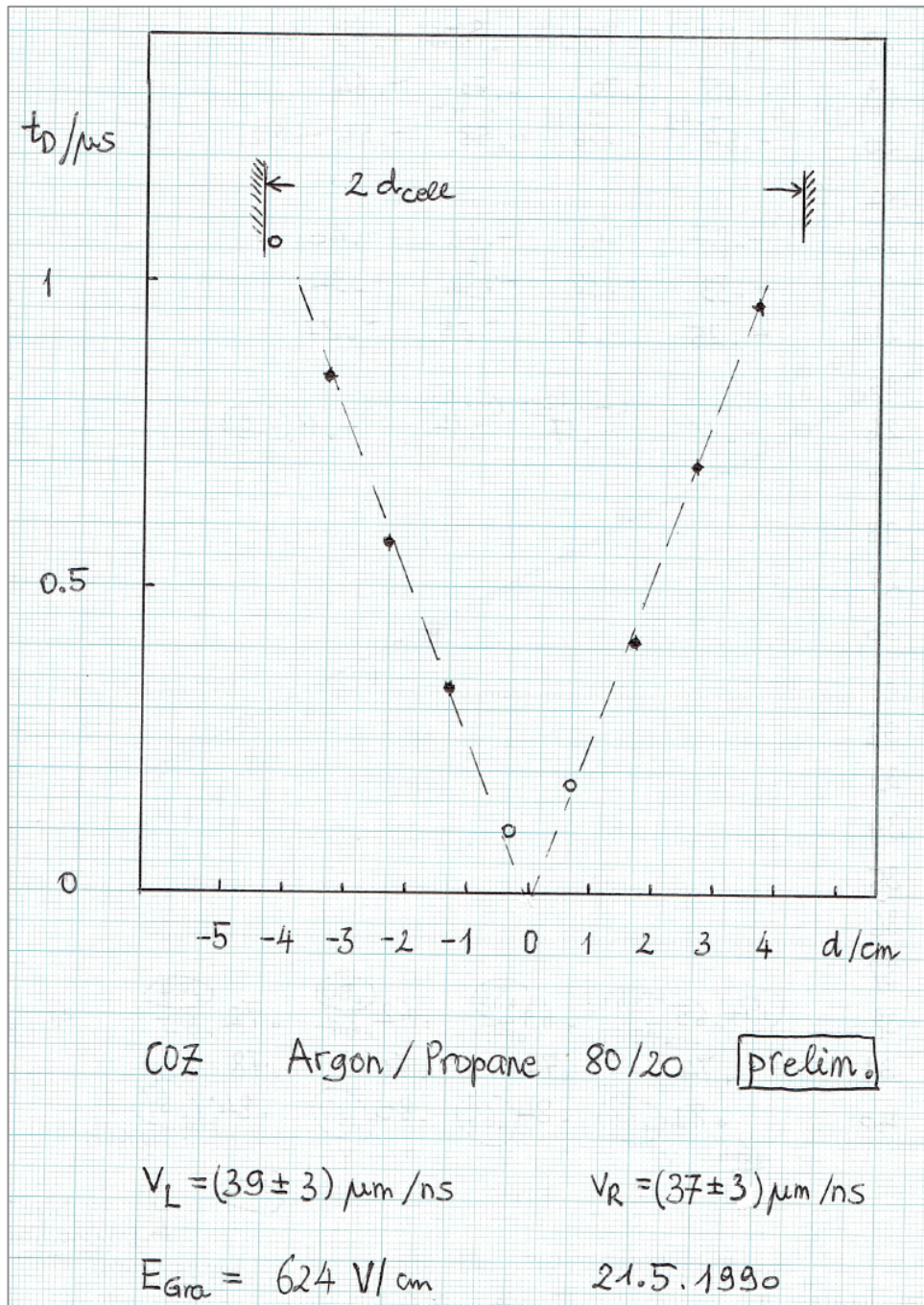

HERA - Inf. Meeting

May 29, 1984

V. Soergel.

6. April 84 : offizieller Start.

official call for letters of intent.

Oct. : Kodifizierung für Kollaborationen.

Finanzen für HERA-Maschine eigensamsten geneigt
 fehlen noch Leute, die an der Maschine mitarbeiten, um 1990 fertig zu werden.

Wirk

complete construction 12.87

e ring 3.88

p 6.89

ep collisions January 1990

need outside manpower!

820 X 30 GeV²
 $0.6 \cdot 10^{32} \text{ cm}^{-2} \text{ s}^{-1}$

free space for exp's 15m
 p e

hid 4.53 .185 T

particles $2.2 \cdot 10^{13}$ $0.76 \cdot 10^{13}$

Erzeuge 300 ... 820 10 ... 33 GeV

ASMW