

**modes SNIM**



UNIVERSITY OF  
**LIVERPOOL**

# Modular Detection System for Special Nuclear Material

Georgios Christodoulou

# Outline

- MODES\_SNM overview
  - Aim of the project
    - Challenges detecting radioactive sources and special nuclear material (SNM)
    - High pressure noble gas detectors as scintillators
    - Software
- Results from the field demonstration in ports and airports across Europe



# modes SNM



5 Countries, ~20 Collaborators



**NARODOWE CENTRUM  
BADAŃ JĄDROWYCH**  
Świerk



Eidgenössische Technische Hochschule Zürich  
Swiss Federal Institute of Technology Zurich



UNIVERSITY OF  
**LIVERPOOL**

# Requirements for a system to detect SNM

- Gamma-ray spectroscopic information
  - Reduce false alarm rate from Naturally Occurring Radioactive Material (NORM)
  - Identify SNM or masked source from its gamma-ray signature
- Distinguish weak neutron source from background
  - Detection of SNM
  - Detection of shielded sources
- Detect neutrons in the presence of gamma source
  - Detection of masked sources
- Thermal neutron detection
  - Detection of shielded sources
- **MODES\_SNM is the first device to meet all the requirements!**

# Radiation detection at ports and airports

- First level of screening is performed by radiation portal monitors (RPM)
  - High efficiency but low resolution detectors
    - Count rate plastic scintillators (PVT) for gamma detection
    - He-3 proportional counters for neutron detection
- Second level of screening is performed by mobile units and small portable identification devices
  - Spectroscopic information using inorganic scintillators NaI(Tl), LaBr(Ce), HPGe detectors
  - Open issues
    - NORM discrimination (false alarm rate)
    - He-3 crisis for the production of neutron detectors
    - Improve the neutron detection for SNM search

# MODES\_SNM

- **MO**dular **DE**tection **S**ystem for **S**pecial **N**uclear **M**aterial
  - Portable radiation scanner to detect illicit nuclear materials
    - SNM (Highly Enriched Uranium and Weapons Grade Plutonium) are difficult to detect
    - Commercial device to be used by the port/airport/border control authorities
    - **Prototype finished and tested by the summer 2014**
  - High pressure noble gas detector technology
    - He-4 fast neutron detector (120-200 bar)
      - He-3 crisis
      - Sensitivity to slow neutron by adding a neutron converted material
        - **First of its type in the world to combine fast and thermal neutron detection**
    - Xenon (20-60 bar) and NaI(Tl) for the gamma detection
      - Gamma-ray spectroscopic information
  - Detect both photons and neutrons (fast and slow)
    - Increase the sensitivity of SNM detection against natural background
    - Discriminate the signal of SNM from other sources of radiation



# Why SNM detection is important

## Nuclear-armed terrorists a real threat to Britain, warns Clegg

By Tom Whitehead, Security Editor

STATELESS terrorists armed with a nuclear weapon pose a very real threat to Britain, Nick Clegg will warn today.

In a stark message, the Deputy Prime Minister will say that the materials to make a dirty bomb are so readily available that no police force can hope to contain such a threat.

Last year, *The Daily Telegraph* disclosed that al-Qaeda was actively trying to secure nuclear material and recruiting rogue scientists to build a radioactive "dirty" bomb.

Mr Clegg issued the warning as tensions continued to grow over Iran's nuclear programme yesterday. David Cameron said an Iranian nuclear weapon would pose a danger to countries outside the Middle East and refused to rule out military action against the regime.

Mr Clegg will call for more co-operation between countries to combat the threat of terrorism during a speech in The Hague this evening.

He will say: "And it is only by working together that we have any hope of tackling the new threats.

"Take a terrorist-executed nuclear attack: unthinkable just a generation ago but now a possibility the international

how advanced, to contain. But together we can agree and enforce the rules that will prevent such attacks. And I'm travelling to a major summit in Seoul later this year to that very end."

The prospect of a terrorist group developing a nuclear weapon or dirty bomb has long been a concern for the security services.

Leaked diplomatic documents last year showed that a leading atomic regulator had privately warned that the world stands on the brink of a "nuclear 9/11".

Security briefings suggested that jihadi groups were also close to producing "workable and efficient" biological and chemical weapons that could claim thousands of lives if deployed.

Thousands of classified American cables obtained by the WikiLeaks website and passed to *The Daily Telegraph* detailed the international struggle to stop the spread of weapons-grade nuclear, chemical and biological material.

At a Nato meeting in January 2009, security chiefs briefed member states that al-Qaeda was plotting a programme of "dirty radioactive IEDs", makeshift nuclear roadside bombs that could be used against troops in Afghanistan.

In his speech, Mr Clegg also called for a more proportionate use of the Euro-

# High pressure noble gas detectors

---



# He-4 as a high pressure neutron detector

- Standard neutron detectors use He-3
  - Rare and expensive
- He-4 has higher cross section than He-3 around 1 MeV
  - Approximately where the neutron spectrum from SNM peaks
- High  $\gamma$  rejection
  - Low energy deposit from Compton electrons
  - Low probability for  $\gamma$  interactions
  - Pulse shape discrimination

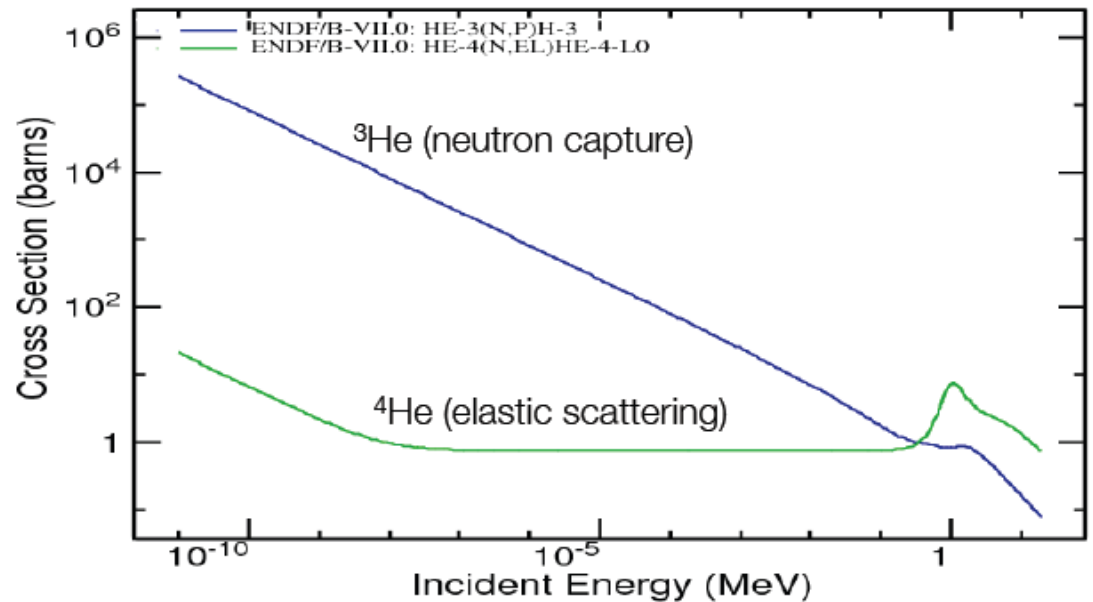

# High Pressure Fast/Slow Neutron He-4 Detector

- Pressurized cylinder (180 bar)
  - Internally coated wavelength shifter and reflector
- Quartz pressure windows
- PMT readout
- Li-6 addition for slow neutron sensitivity

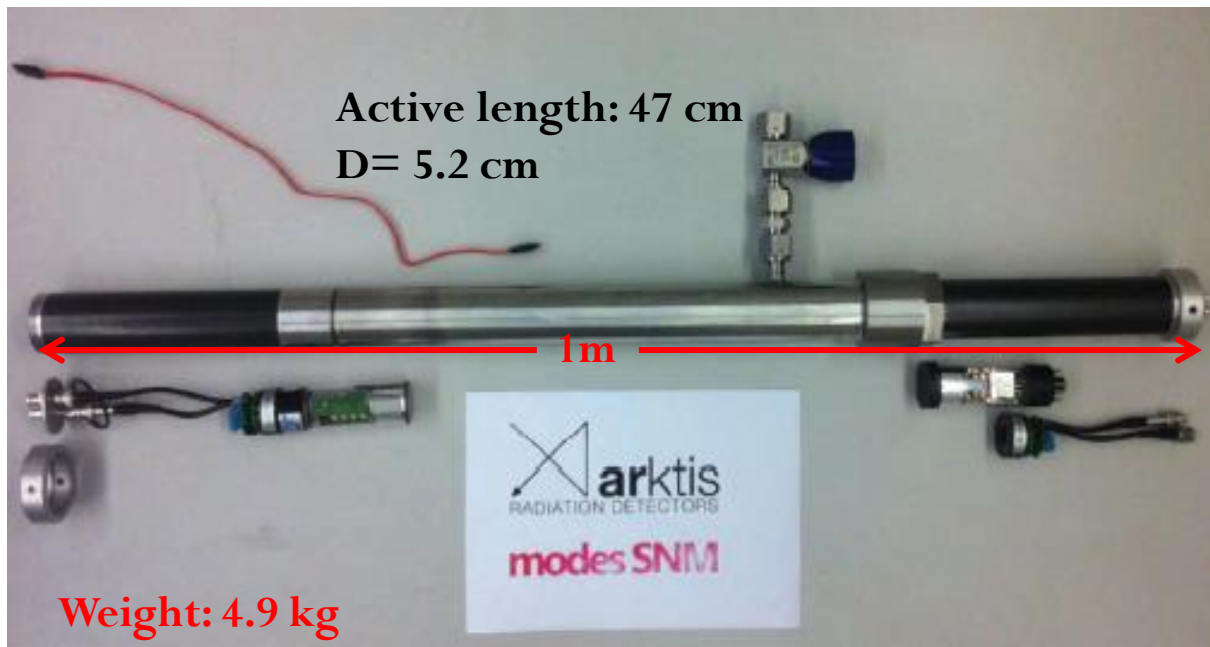

# Neutron-Gamma discrimination using the fast neutron detectors

- Requirements (from IAEA)
  - Alarm in 2 s
  - False alarm rate  $< 0.001$
  - Probability of detection (PD) at 95% CL  $> 90\%$
  - *Time to identify source*  $< 60$  s

$\sim 7\%$  fast neutron efficiency (Cf-252)

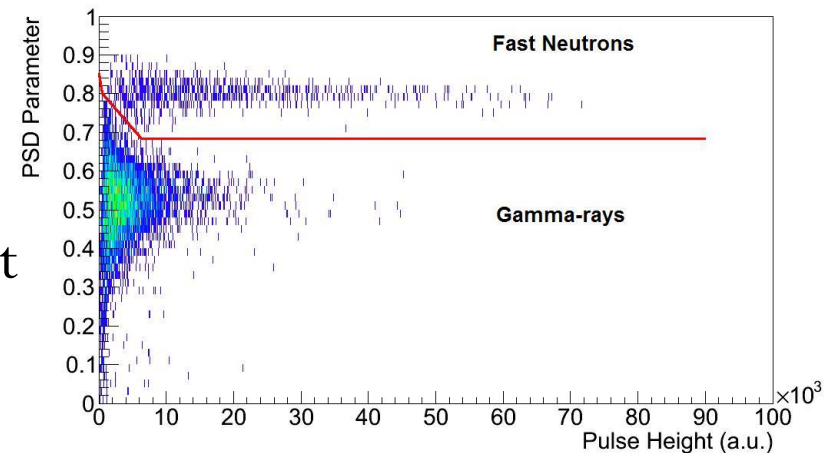

detector type	detection mode	cycle time	CL	
He4	ALARM	<b>2 s</b>	<b>95 %</b>	
source	shielding	number of trials	number of true positives	PD
Cf-252	-	449	448	<b>97.4 %</b>

# Minimum number of fast neutron detectors required

Number of detectors	Number of trials	Avg. bckg. cps	Alarm threshold	Avg. neutron cps	Number of alarms	PD
2	449	0.08	1	2.73	341	70.7%
3		0.13	2	4.07	341	70.7%
4		0.24	2	5.95	417	89.4%
5		0.30	2	7.57	438	94.8%
6		0.36	3	9.11	438	94.8%
7		0.41	3	11.02	446	96.9%
8		0.45	3	12.55	448	97.4%

# Li-6 coated neutron detector

## Co-60

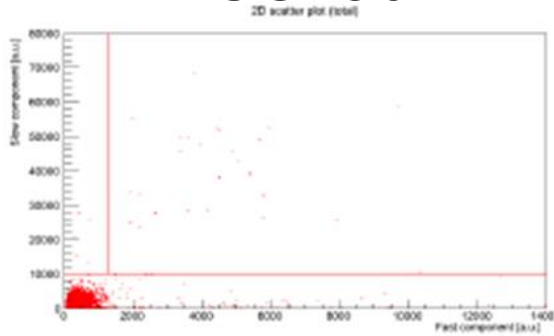

Fast Component Projection

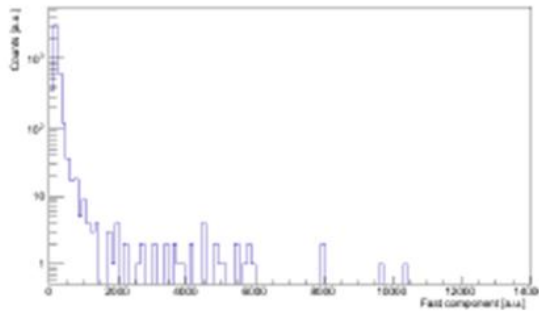

## Cf-252

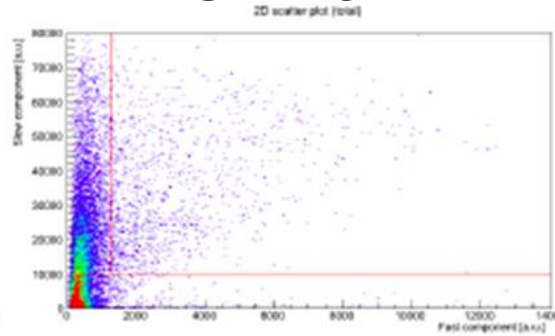

Fast Component Projection

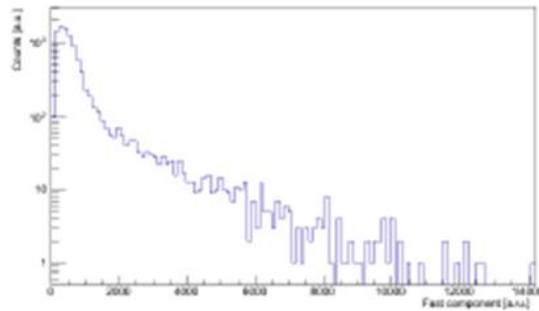

## Cf-252 + shielding

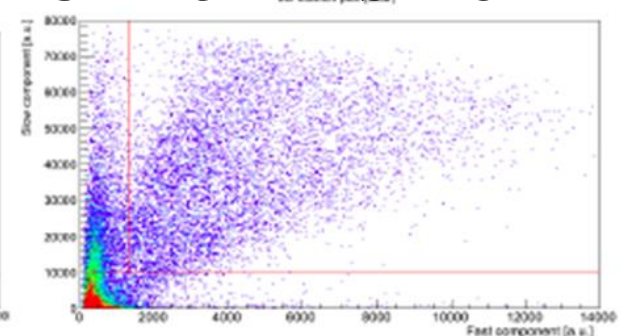

Fast Component Projection

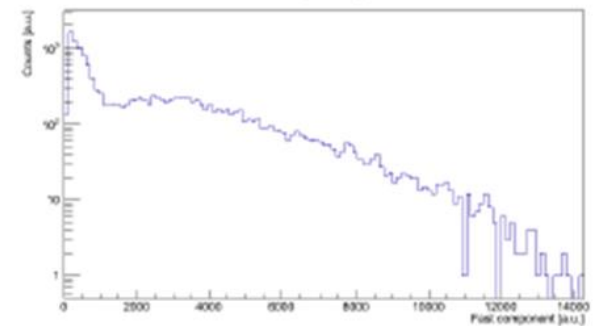

# Characterization of the slow neutron detectors

- Thermal to fast neutron ratio
  - $R = 0.20 \pm 0.27\%$  for Cf-252
  - $R = 3.26 \pm 0.18\%$  for Cf-252 with shielding
- $R > 0.5$  points to neutron source shielded with hydrogen-rich material



# High Pressure Xenon Photon Detectors

- ~30% efficiency  $< 1$  MeV
- Smaller but wider tube compared to the fast neutron tube
  - Active length: 20 cm
  - $D = 11.5$  cm
  - 13 kg

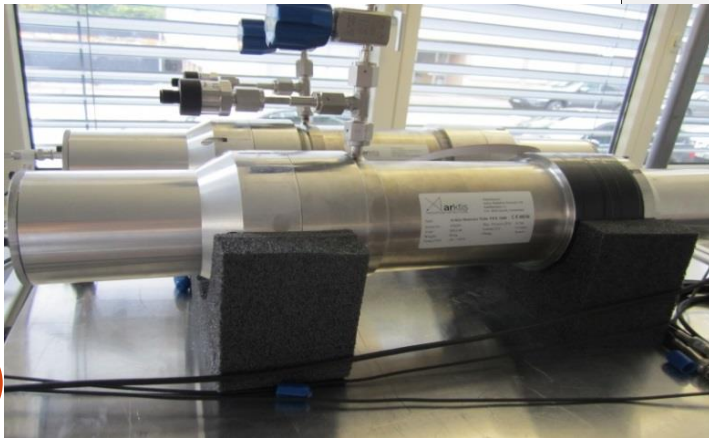
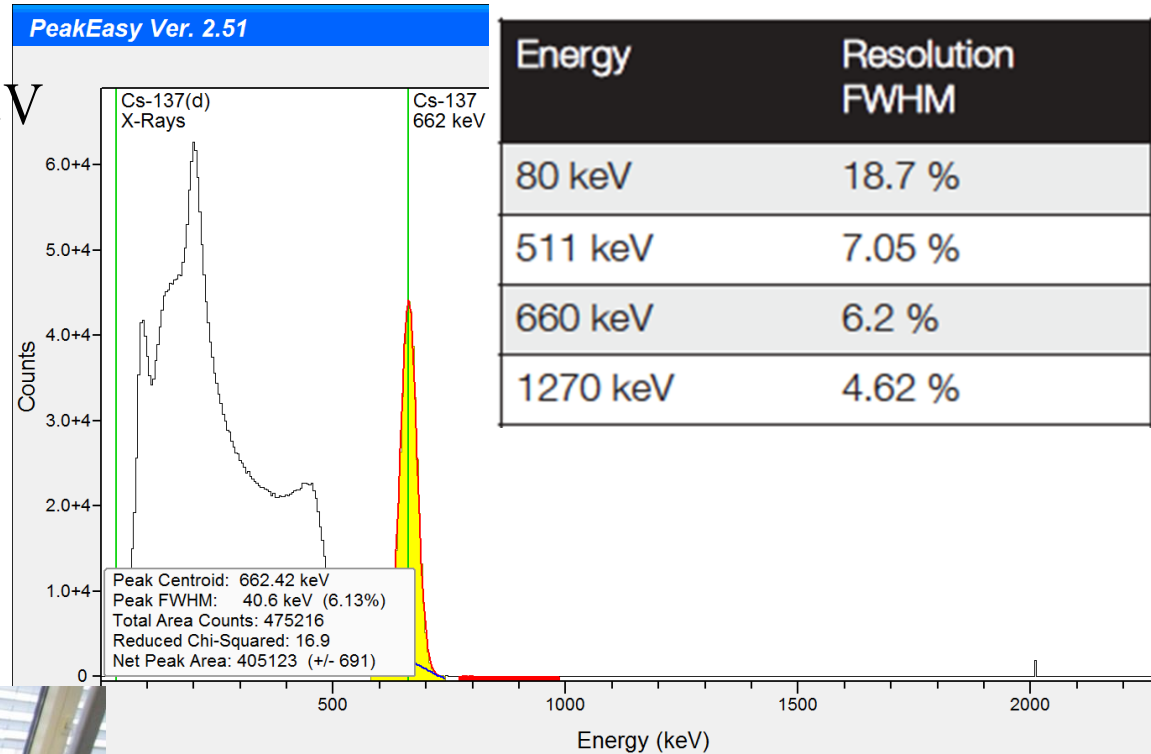



# Gamma ray detection

- Requirements (from IAEA)
  - Alarm in 2 s
  - False alarm rate  $< 0.001$
  - Probability of detection (PD) at 95% CL  $> 90\%$
  - Time to identify source  $< 60$  s

<b>detector type</b>	<b>detection mode</b>	<b>cycle time</b>	<b>CL</b>
Xe	ALARM	<b>2 s</b>	<b>95 %</b>
<b>source</b>	<b>number of trials</b>	<b>number of true positives</b>	<b>PD</b>
Co-60	450	450	<b>97.6 %</b>
Cs-137	450	450	<b>97.6 %</b>
Am-241	449	449	<b>97.6 %</b>

# Gamma ray sources for system characterization

- The source-detector distances for all sources were adjusted to produce 50nSv/h dose rate at the detector

Source	Gamma-ray energy (keV)	Activity (kBq)	Distance to produce 50 nSv/h dose rate (cm)
Am-241	59.6	18500	120
Cs-137	662	641	99
Co-60	1173 1333	239	121
Eu-152	122 245 344 779 1408	319	89
Na-22 (PET-type source)	511 1275	316	133
Cr-51	320	12800	104
Ba-133	81 276 / 303 * 356 / 384 *	979	96
Co-57	122	3622	91
Cd-109	22 88	718	80

# Source identification in 60 s

**Am-241: 60 keV**

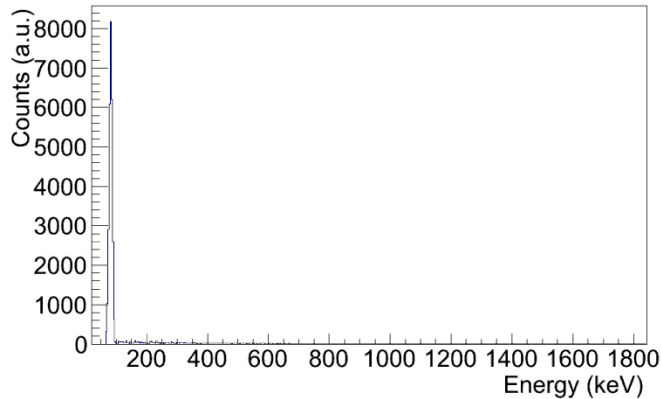

**Ba-133: 81 keV, 276/303 keV  
356/384 keV**

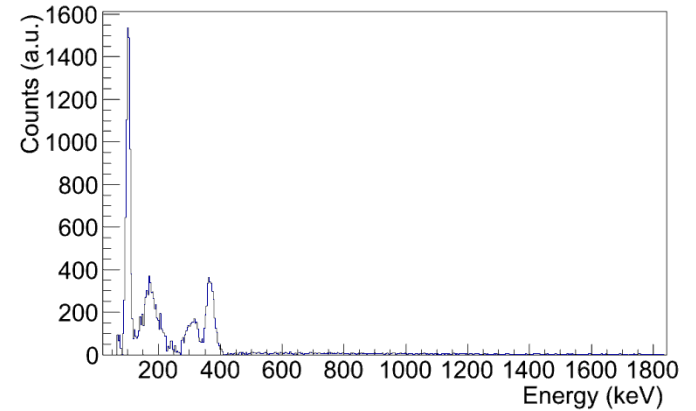

**Na-22 (PET): 511 keV**

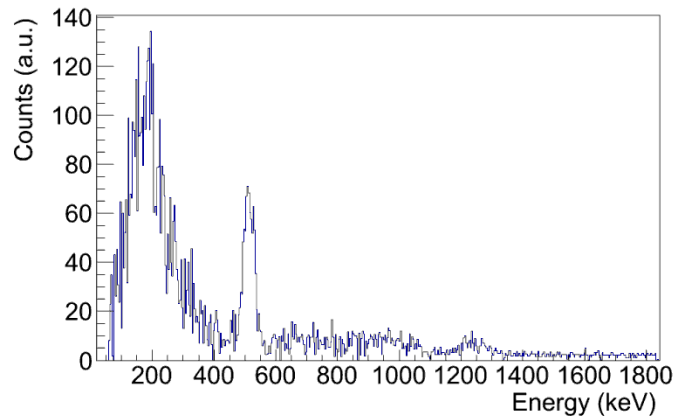

**Co-60: 1173 keV, 1333 keV**

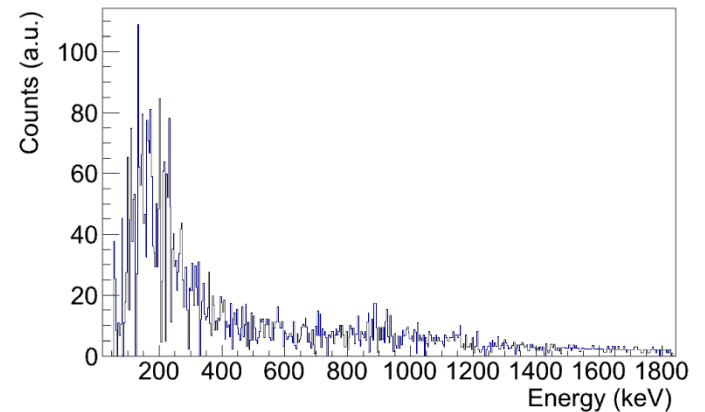

# NaI(Tl) detector to replace one of the two xenon detectors

- Existing (From the FP6 EUROTRACK project (2005-2010)) large volume (12.5 cm x 12.5 cm x 25 cm) NaI(Tl) to replace a xenon detector
- Energy resolution is equivalent to the one measured with Xe detectors
- Efficiency is very large at 1 MeV,  $\sim 40\%$

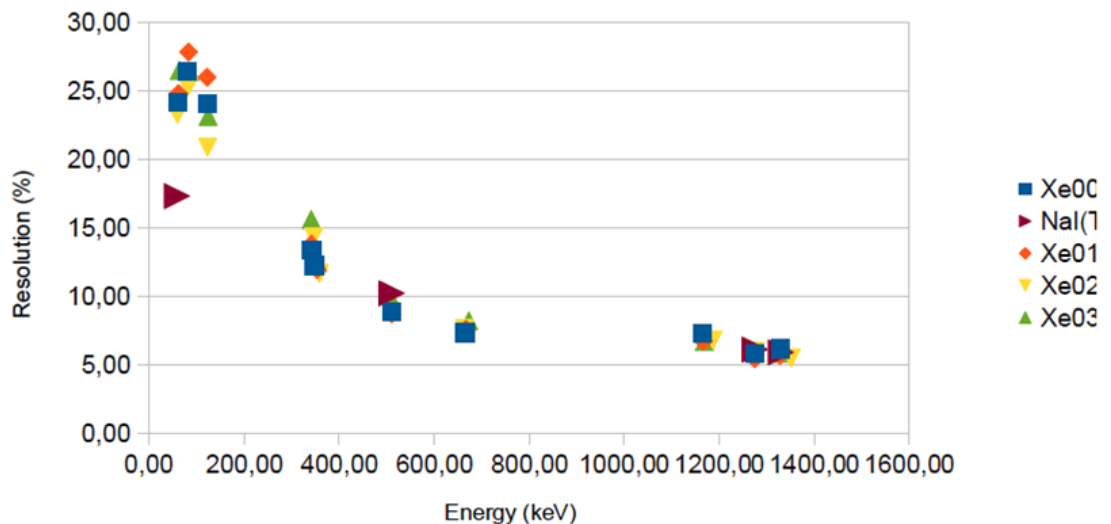
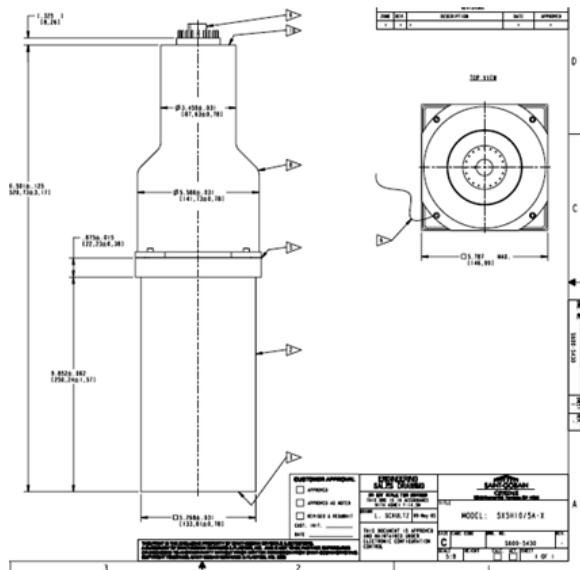

# Performance of the NaI(Tl) detector

- Large efficiency allow to detect weak radioactive sources with activity 50nSV/h

3. Subtraction of measured background

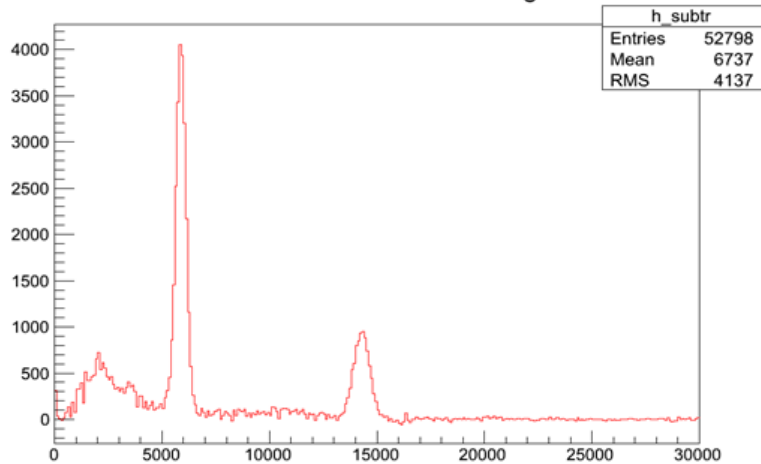

**Background subtracted  $^{22}\text{Na}$  spectrum measured with the NaI(Tl) detector. 50nSv/h dose rate, 60s measurement.**

# Gain drift of the NaI(Tl) detector

- NaI(Tl) detector is characterized by a gain drift
- Use a “KCl pulser” providing enough counts at 1.4 MeV that allow to stabilize the energy spectrum by an automatic cycle using acquired data in absence of gamma alarms
- All detector parameters (gains, thresholds) are set to optimal values and are not requiring operator actions.
- Initial calibration is needed
  - Cs-137 and Co-60 sources selected

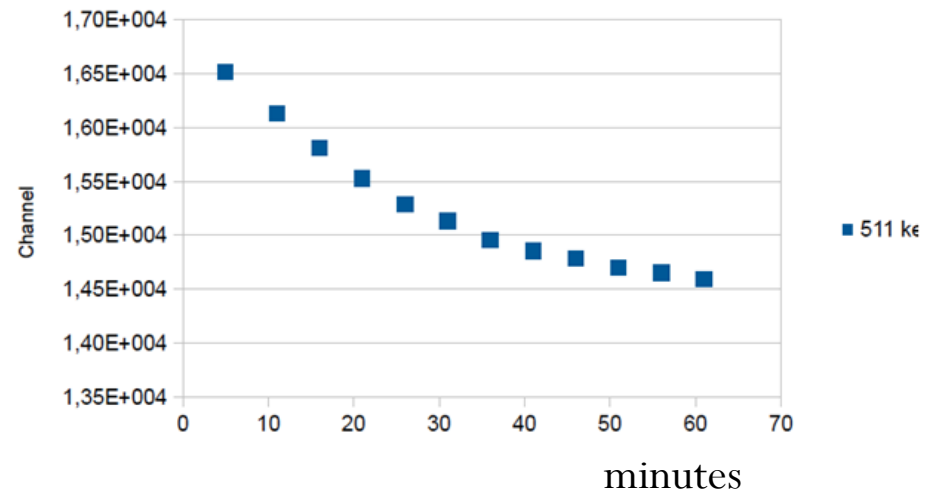

# Alarm results with static source

Type of event	Gamma Alarm	Neutron Alarm	Thermal Neutron Alarm	Message to the operator
Radioactive Source	YES	NO	NO	Type of source (within the implemented library)
NORM	YES	NO	NO	Type of NORM (within the implemented library)
Heavy lead shielded neutron source	NO	YES	NO	Lead shielded neutron source
Poly shielded Neutron source	YES	NO	YES	Poly shielded neutron source
Poly and lead shielded Neutron source	NO	NO	YES	Poly-Lead shielded neutron source
<sup>252</sup> Cf source	YES	YES	NO	<sup>252</sup> Cf source
Am/Be or Pu/Be source	YES	YES	NO	(alpha,n) neutron source
Pu source	YES	YES	NO	Pu source
U source	YES	NO	NO	U source



# Neutron alarm results from a moving source at JRC-Ispra

- Requirements

- Generate neutron alarm for a Cf-252 source emitting  $1.2 \times 10^4$  neutrons/sec and moving with a speed of 0.5 m/s (1.8 km/h) at a distance of closest approach between the source and a Portable Radiation Scanner of one meter

Source	Speed (km/h)	Alarms/trials
Cf-252	1.8	30/30
Cf-252	4.3	28/30
Cf-252	7.9	23/30
Am-Be	1.8	10/10
Am-Be <sup>1</sup>	1.8	10/10
Am-Be <sup>2</sup>	1.8	10/10



1. Shielded with 1 cm iron and 1 cm lead
2. Shielded with 1 cm iron and 1 cm lead and 8 cm poly

# Identification of Pu source at JRC-Ispra

- Identification of Pu samples (6g enriched Pu-239)

Sample	Mass fraction of Pu-239 (%)	Shielding	Results	Identification
CBNM61	62.5	None	5/5	Pu
CBNM61	62.5	1 cm iron + 1 cm lead	5/5	Pu
CBNM61	62.5	1 cm lead + 1 cm iron + 8 cm poly	5/5	Pu and poly shielding
CBNM93 <sup>1</sup>	93.4	1 cm lead + 8 cm poly	7/9	Neutron alarm

1. Source was too far to provide fast neutron alarm. The identification of Pu need to be implemented since the 600-800 keV structure is very weak in case of 93% enriched Pu

# Gamma alarm from a moving source at JRC-Ispra

- Requirements
  - Generate gamma alarm when the gamma ray source is moving with a speed of 0.5 m/s (1.8 km/h) at a distance of closest approach of one meter between the source and the front face of the prototype

Source	Speed (km/h)	Dose rate	Alarms/trials	Identification
Co-60	1.8, 4.3, 7.9	50 nSV/h	30/30	10/10
Ba-133	1.8, 4.3, 7.9	10 nSV/h	30/30	10/10
Am-Be	1.8	50 nSV/h	30/30	10/10
Am-Be	4.3	50 nSV/h	20/30	10/10
UP8996 <sup>1</sup>	0		5/5	5/5

1. 51g 90% enriched U-235

# Software

---

# Software structure

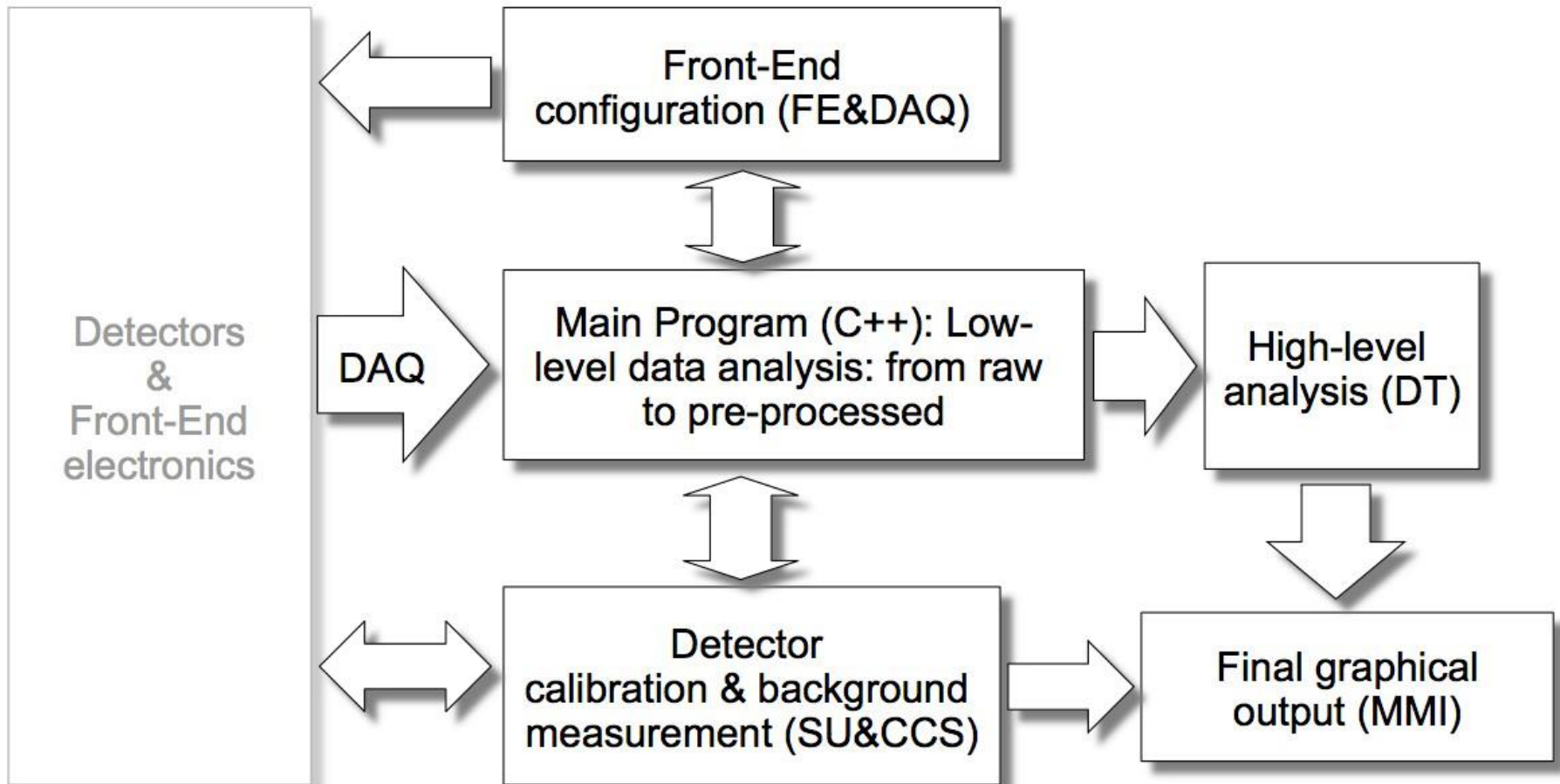

# Man made interface (MMI) system

- Running MODES on every modern device



# MODES Software v-1.0

- The main GUI panel provides:
  - run/stop acquisition
  - system status (with automatic notification in case of failures)
  - alarm notification (visual and sound)
  - launch automatic system calibration and isotope identification
  - system messages

The screenshot displays the MODES SNM software interface. At the top, the title "modes SNM" is shown in red. Below it, a navigation bar includes tabs for CONTROL, PLOTS, HW\_MON, CONF, and LOG, along with a speaker icon for sound. A secondary bar shows status indicators for SYS, BATT, TEMP, DET, ACQ, and GPS. The main display area shows "System ready" and several data panels:

- A "LEFT" panel with a 0s timer and a bar chart.
- A panel with a tree icon and a radiation symbol.
- A panel with a magnifying glass icon.
- A battery status panel with a lightning bolt icon.
- A panel with a red background and a white  $\gamma$  symbol.
- A panel with a white  $n$  symbol on a black background.
- A panel with a white  $n$  symbol on a black background.

Below these panels, a log window displays the following messages:

```
[16:58:28] Acquisition started in search mode
[16:58:27] Calibration procedure completed
[16:57:24] Started calibration procedure (60s)
[16:57:19] Acquisition started in search mode
[16:57:07] === MODES v. 1.0 ===
```

At the bottom, there are three large control buttons: a green power button, a grey play button, and a black square button.



# System monitor during operation

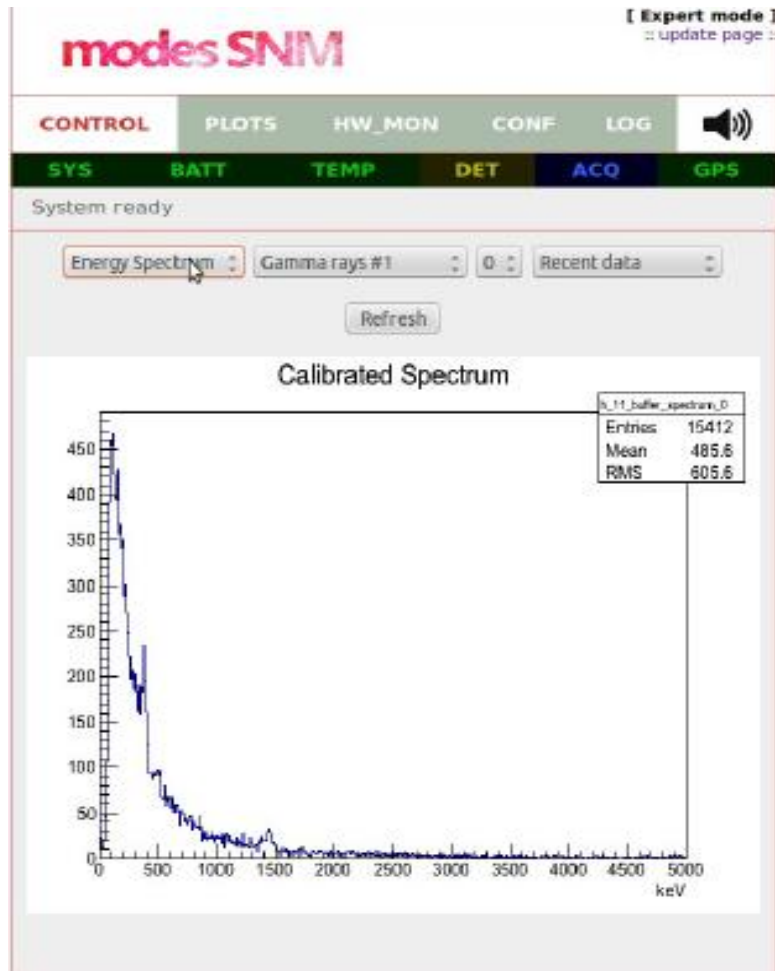

[ Expert mode ]  
:: update page ::

**modes SNM**

CONTROL SETUP PLOTS **MONITOR** CONF LOG

SYS BATT TEMP DET ACQ GPS

System ready

Detector	HV [V]	T [°C]	P [kPa]
Fast neutrons #1 Neutron box #5, top	1350	0.0	0.0
Fast neutrons #2 Neutron box #5, bottom	1250	0.0	0.0
Fast neutrons #3 Neutron box #4, top	1400	0.0	0.0
Fast neutrons #4 Neutron box #4, bottom	1450	0.0	0.0
Fast neutrons #5 Neutron box #3, top	1400	0.0	0.0
Fast neutrons #6 Neutron box #3, bottom	1400	0.0	0.0
Fast neutrons #7 Neutron box #2, top	1400	0.0	0.0
Fast neutrons #8 Neutron box #2, bottom	1300	0.0	0.0
Thermal neutrons #1 Neutron box #1, top	1600	0.0	0.0
Thermal neutrons #2 Neutron box #1, bottom	1600	0.0	0.0
Gamma rays #2 Gamma box #2 Xenon	1000	0.0	0.0
Gamma rays #1 Gamma box #1 NaI(Tl)	1100	0.0	--

# System monitor during operation

**modes SNIM** [ Expert mode ]  
:: update page ::

CONTROL PLOTS HW\_MON CONF LOG

SYS BATT TEMP DET ACQ GPS

System ready

Detector:  SAVE

### Fast neutrons #5 bottom

Power supply:  V (+)

Scope samples:  samples

DC offset:

Threshold:

Pre trigger:  samples

PreGate:  samples

Gate short:  samples

Gate long:  samples

Charge sensitivity:

Coinc. window:  ns

**modes SNIM** [ Expert mode ]  
:: update page ::

CONTROL PLOTS HW\_MON CONF LOG

SYS BATT TEMP DET ACQ GPS

System ready

### Official log:

```
[17:02:00] --- START [0g]---  
[17:02:00] Load source: 240Am with 1 peaks  
[17:02:00] Load source: Zn0x with 1 peaks  
[17:02:00] Load source: 40K with 1 peaks  
[17:02:00] Load source: 137Cs with 1 peaks  
[17:02:00] Load source: 60Co with 2 peaks  
[17:02:00] Load source: 22Na with 2 peaks  
[17:02:00] Loaded alarm thresholds: g=3542 f=2 t=2  
[17:02:00] Load NaI(Tl) calibration: m=0.116602 q=-27.517599  
[17:02:00] Load CTR value: 1.600000  
[17:01:58] DMS: found 0 detectors. Not working.  
[17:01:58] DMS: initializing...  
[17:01:49] Server started with 3 HWs and 3 digitizers
```

### Console output:

```
DGTZ #0: Operation completed successfully [Activate]  
DGTZ #1: Operation completed successfully [Activate]  
DGTZ #2: Operation completed successfully [Activate]  
HW: Operation completed successfully  
HW: Operation completed successfully  
HW: Operation completed successfully  
Port config file written.
```

# MODES software v-2.0

- Final version of the software released in June 2014 (after field demonstration)
- Major changes:
  - Graphical gamma rate monitor
  - Improved user messages
  - Complete log of the acquisitions
  - Better rate estimation
  - Variable identification time
  - Redesign of log system

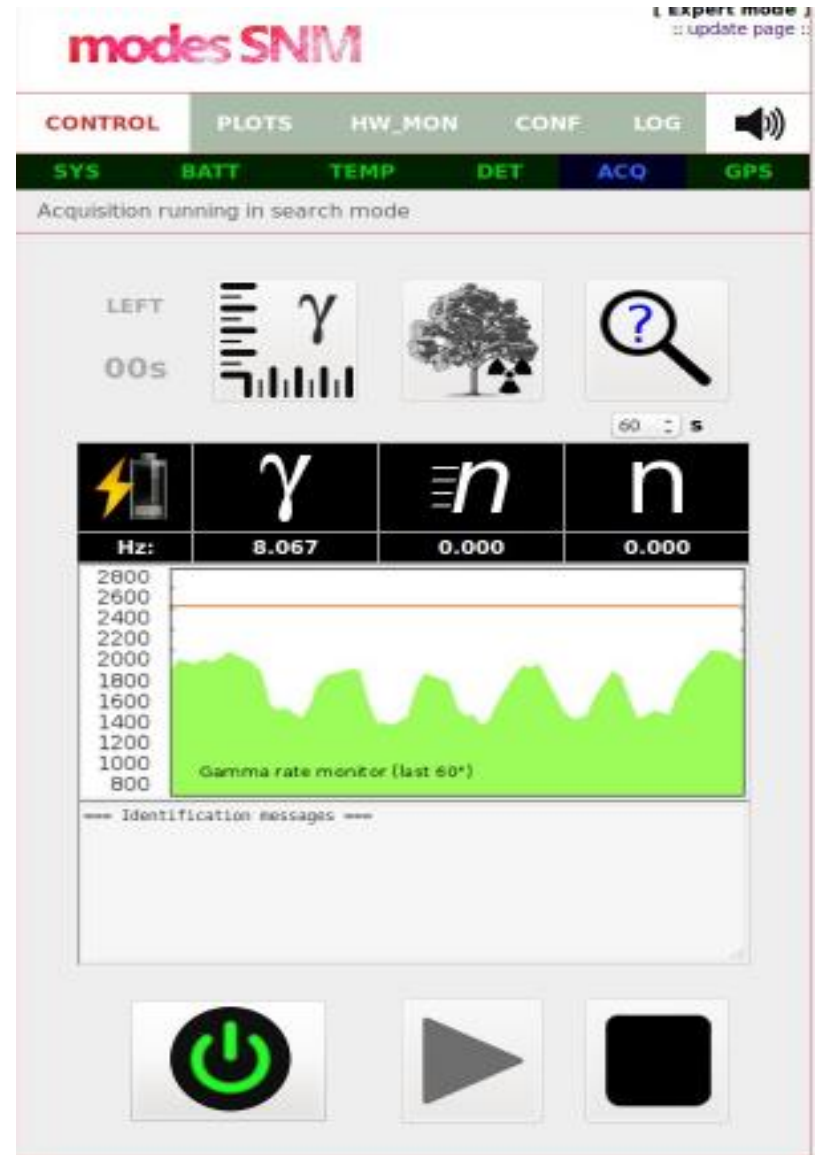

# System integration

---

# MODES system architecture

## Interfacing the Electronics with IS and Detectors

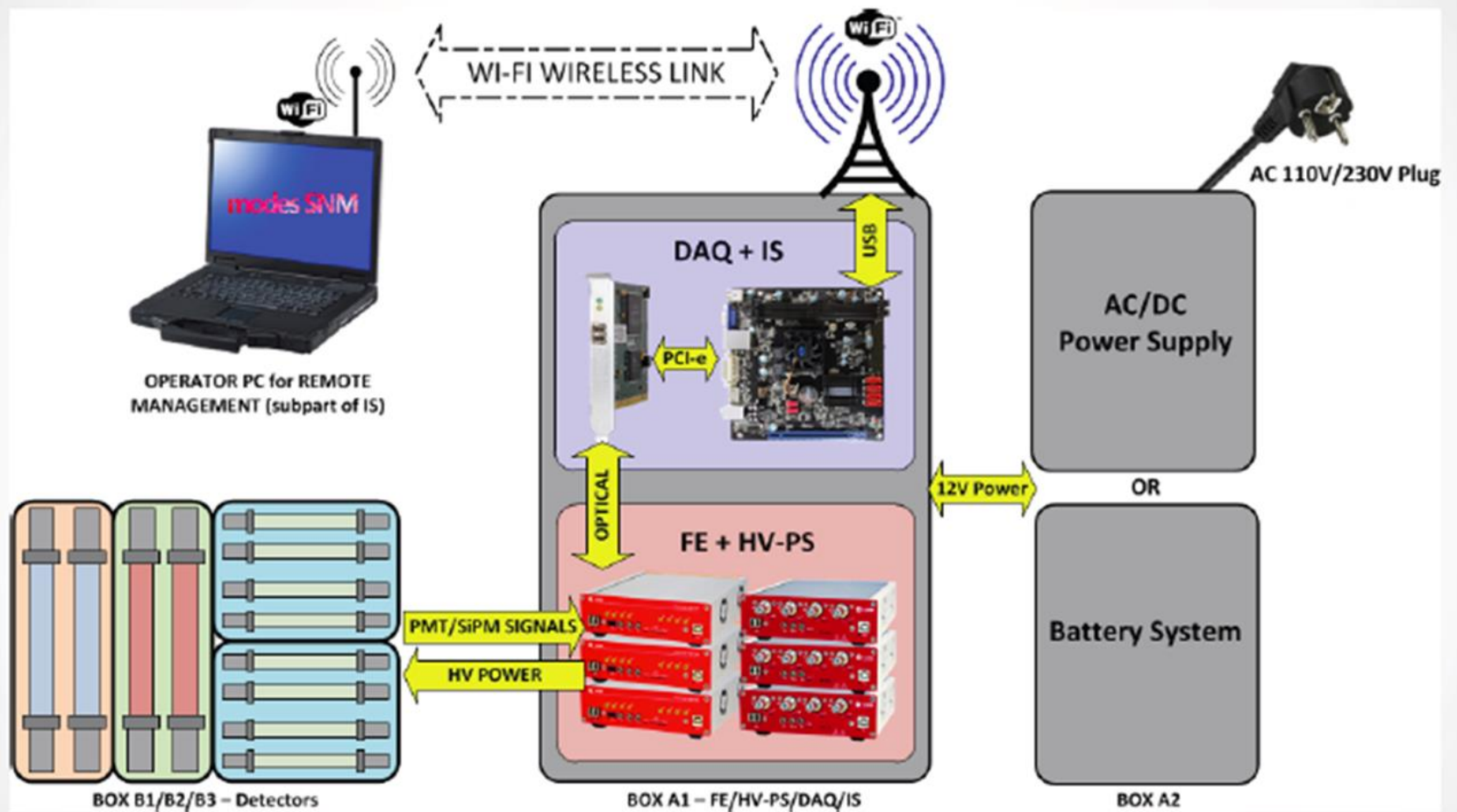



# Neutron detector installation

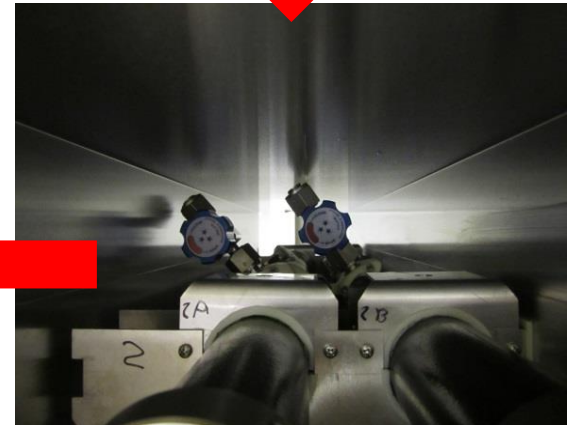
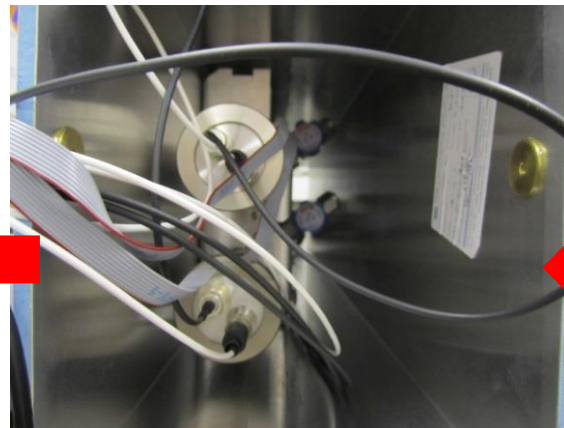
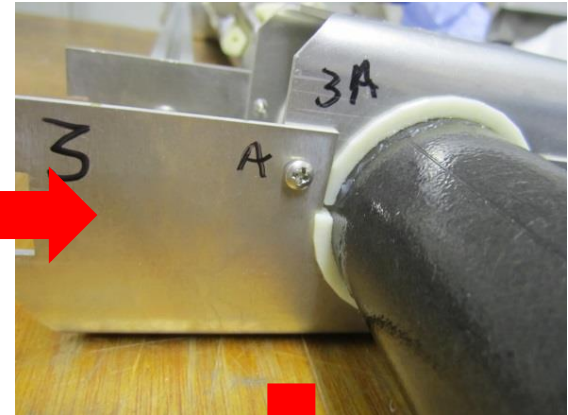
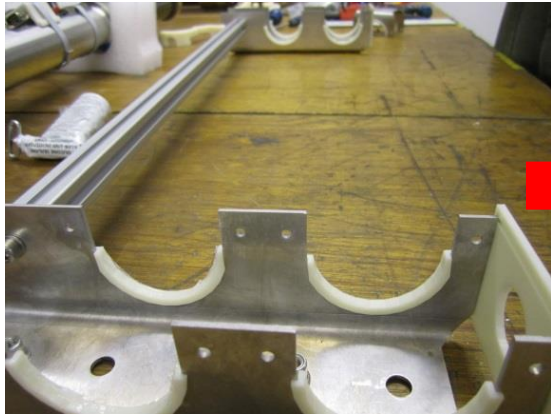

# Electronics and computer installation





# Complete prototype



- 4 boxes with 8 fast neutron detectors
  - Each box weights 17.5 kg
- 1 box with 2 slow neutron detectors
  - Weights 17.5 kg
- 2 boxes with 2 gamma detectors
  - Each box weights 18.5 kg
- 1 electronics and computer box
  - Weights 32.5 kg
- 1 battery
  - Weights 13.5 kg

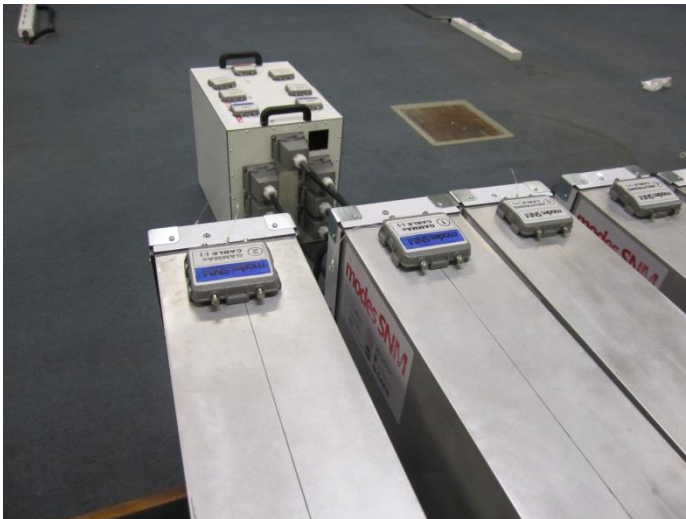

# MODES prototype to Poland

- MODES prototype shipped to Warsaw at the beginning of December 2013
- Install some missing parts
  - 1 xenon tube
  - 1 neutron tube
  - Pressure and temperature readouts for the xenon detectors
- Install the first software version
- Take first data
- MODES\_SNM stayed in Poland for 3 months for the lab characterization



# Van mounted system

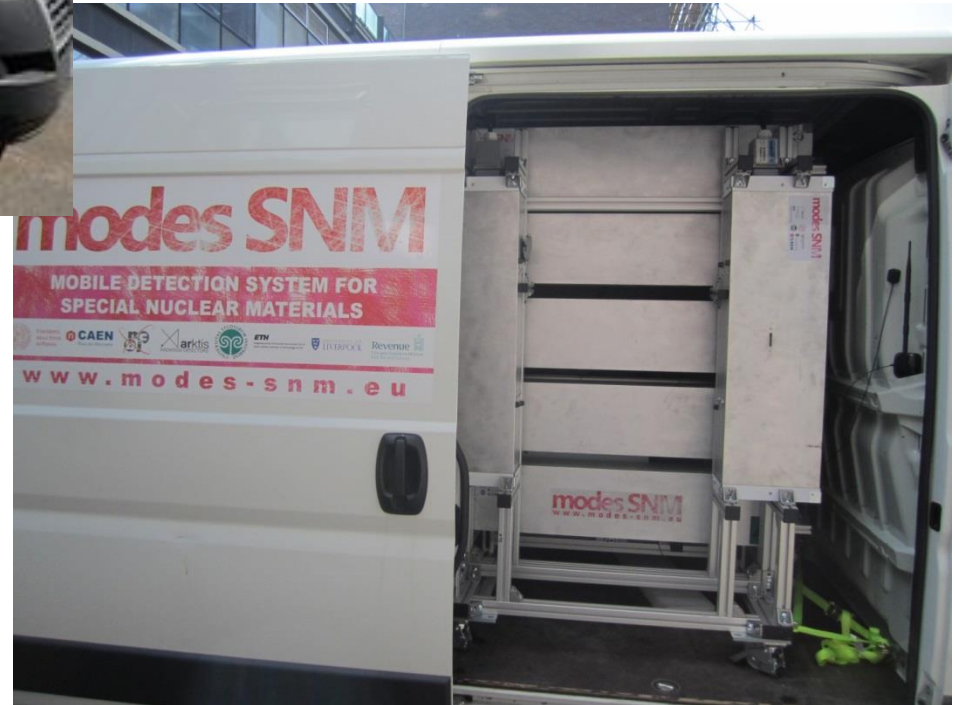

# Field demonstration

---

# Sides selected for the field demonstration

- Rotterdam port
  - Largest and busiest port in Europe
  - > 0.5 million containers / month
  - Most advanced port security in the world
    - Borrowed by DOE
    - Research staff (mostly physicists) on board
- Heathrow airport
  - Busiest airport in Europe
  - ~70 000 freights / month
- Dublin port
- Swiss border at Basel
- MODES operated from port/airport authorities for a big fraction of demonstration time





# Rotterdam seaport field tests



**MODES\_SNM operated against a Radiation Portal**



**MODES\_SNM operated against a SAIC 460 van mounted system**

# Demo at Rotterdam port

Mode	Vehicles scanned	True alarms	False alarms	Identified
Static	131	4	1	2
Secondary inspection	6 (5 true + 1 false alarms from the RPM)	5	0	3
Mobile (~10 km/h)	Few hundred	1	Few	1

~99% of alarms at Rotterdam port are due to NORM. MODES\_SNM has been optimized against SNM

# Additional tests at Rotterdam

- Ceramic plate with  $^{235}\text{U}$ , 135 nSV/h at contact. Alarm at contact and identification
- Thorium mandles 53 nSv/h at 15 cm alarm and ID OK but  $^{133}\text{Ba}$  was also found ( $^{133}\text{Ba}$  has a gamma line having the same energy of one from the Thorium decay)
- Zr sand 370 nSv/h at 30 cm ID as ZrO (as in the library)
- $^{133}\text{Ba}$  ok at 10 km/h with identification





# Dutch customs report

- **“Very easy to use!** The start-up of the Van is very simple and can be done in a very short period of time. Within a few minutes you’re operational. Show the procedure once to an officer and the next time he’s able to use the system without any help...”
- **“The MODES SNM Van alarms very fast.** Though caused many times by the natural variation of the background, it looks as if the system is capable of detecting very small variations of radiation levels and therefor suitable to detect sources that are hidden in cargo but that still send out some radiation...”
- **“Modular built.** The system was set up in a more or less one sided detection configuration. By rearranging the configuration, for instance installing the gamma detectors at the side of the neutron detectors and placing the battery and electronics out of the detection view, you could have a bidirectional system...”

# Dutch customs report – list of improvements

- “At start-up of the system we had several times problems staying connected to the Wi-Fi network. Only after resetting the network the system stayed connected. After that we never lost connection...”
- “When driving around, on many occasions we had gamma alarms, due to the variation in the background. By adding a graphic display of the measured count rate over time, it will be easier to distinguish between alarms caused by background variations or by radiation emitting containers...”
- “After alarming on many occasions the identification was not always perfect. Especially in the presence of NORM nuclides in the cargo. When we used the very small Co-60/Cs-137 calibration source in such a way that the count rate (CPS) was approximately the same level as the gamma alarm cause by NORM, the identification of the source was correct...”

# Dutch customs report – conclusions

- **“My conclusion is that MODES SNM has a lot of potential, but the software that comes along with it has to be improved, especially the background algorithms and the identification of NORM nuclides. When I look at the ISPRA results, the SNM performance is good. But in the Port of Rotterdam about 98 to 99% of all alarms are caused by NORM nuclides...”**
- **“I think that even when the “background” problems will be solved the MODES SNM will certainly be very usable as a Mobile system, but also in a stationary way when used next to fixed portals...”**
- **“Fluctuations in background, caused by variety of pavements and materials in the ground, will always trigger an alarm because of the high sensitivity of the system...”**

# Demo at Heathrow airport

- **First large scale project allowed to operate inside the airport!**
- Operated in stationary mode and as secondary inspection
- Vehicle speed 5-10 km/h
- Usual medical isotope transportation
  - Not included in MODES libraries



# Joining the UK border force





# Operating next to terminal 3



# Results from Heathrow airport demo

Vehicles scan	Alarms	Identification	False alarms
635	2	1	Few/day

I235, Y90 are not in the IAEA list. Y90 medical isotope 60h half-live beta emitter almost no gamma

I125 medical isotope 39d, EC to 125Tl that emits gamma of 35 keV



Blind test on containers to store all contaminated objects  
Co-60 source correctly identified

# Heathrow report

- “The simple 3 button approach and output log screen is very appealing to non expert users and also allows the user to see what the system is doing. Also the capability for the user to be separated from the system itself with the laptop is very useful. This enables users to not be solely dedicated to the system...”



# Results from Dublin port

MODES\_SNM used to within 50 m of Customs mobile X-ray Imaging system (NUCTECH 6 MeV) without interference



Test with moving Pu/Be Neutron source at University College Dublin. Detection at 8 km/h 1m distance to 20 km/h 4m distance



# Results from Dublin port

- Deployed to scan car ferry traffic, maritime containers, bulk cargo, palletised warehouse cargo in both static and mobile modes
- 2 NORM alarms in cargo
- Gamma background alarms resulting from varying nature of construction materials
- Some gamma & neutron alarms when no target present



# Results from Basel demonstration



218 trucks with speed 5-25 km/h  
3 NORM identification



Integration and lab tests ~ 6 000 km

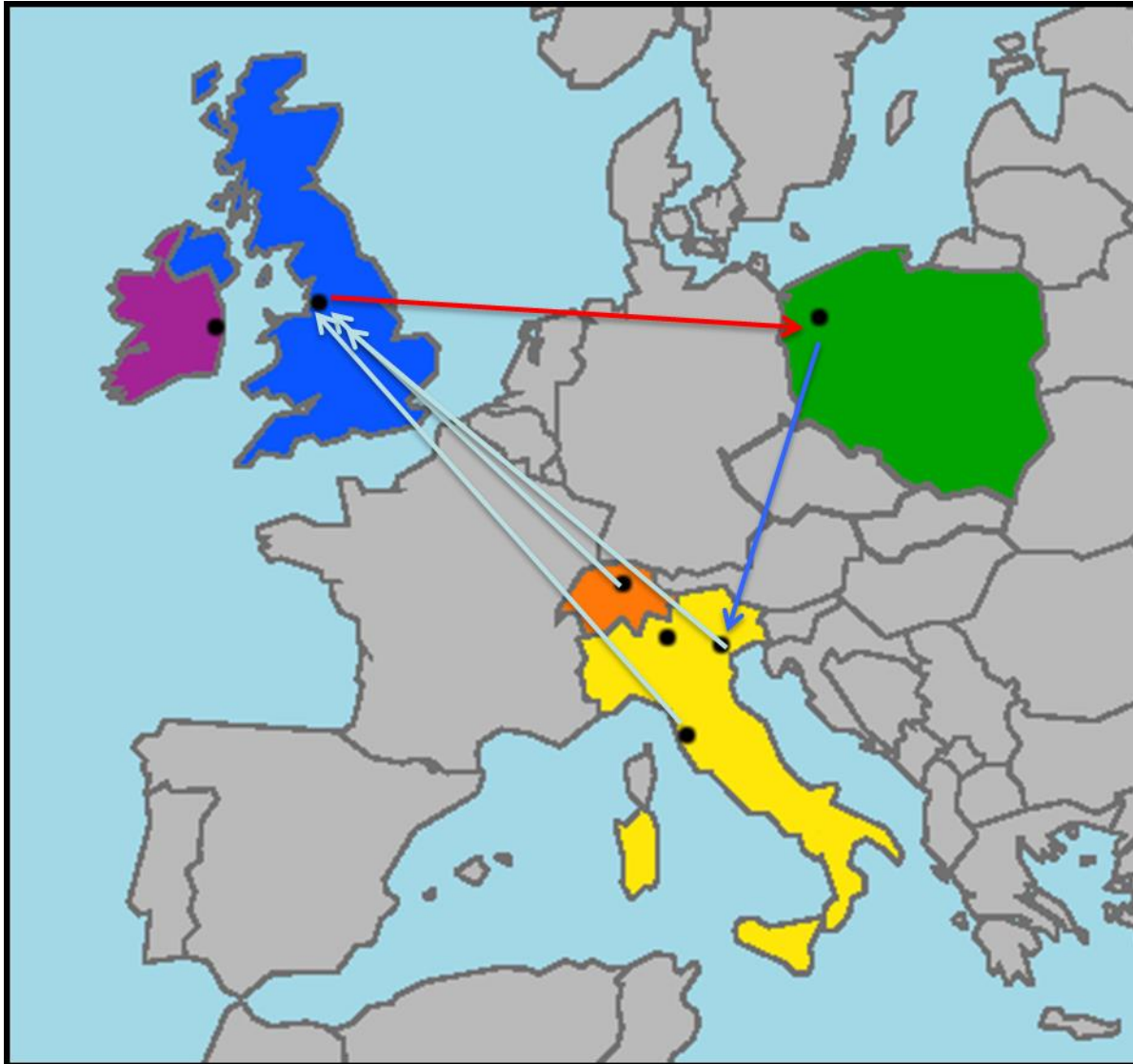

Demonstration ~10 000 km

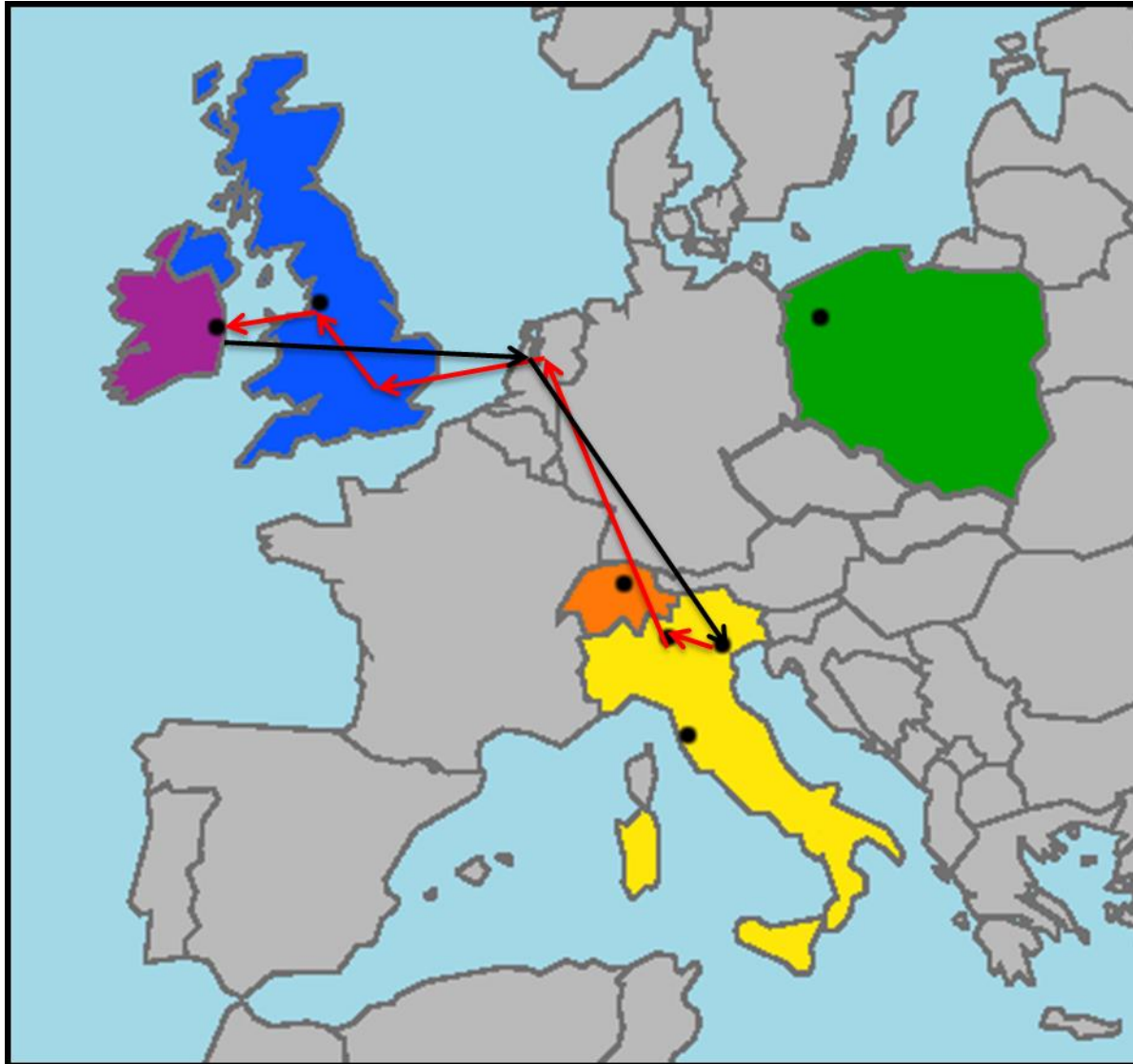

...and sometimes the transportation was not very professional...



# Positive feedback

- Performance of system exceeded expectations for a prototype
- System availability exceptional (no downtime)
- Impressive sensitivity
- Fast response times
- Van mounted format very useful in operational environment
- Remote interface access & Wi-Fi
- Mobility and flexibility

# List of future improvements

- Improvements to reduce false alarms to an acceptable level
  - Occupancy sensor
- A solution to deal with gamma alarms for elevated background levels when using in drive by mode
- A curtain to protect the system from dust and rain to allow the system to be used with an opened door
- Different audible alarms for gamma, fast neutron and thermal neutron alarms
- Display of dose rate in addition to count rate
- Ability to retrieve log information
- Highlighting of important events in log
- Extension of radionuclide library



# Other on-going activities

- Application of SiPM
  - Cheap, robust, insensitive to magnetic fields, no high voltage
  - Successfully used by high energy physics experiments (T2K, XENON)
- **Simulation**
- Measurement of the non-proportionality and energy resolution of pressurized Xe scintillator
  - Compton coincidence technique
- **Source identification algorithms**
  - Peak finding algorithms and analysis for the gamma detectors
  - **Response function analysis**
  - **Neutron spectra analysis**
    - Energy window
    - Shape analysis

# Neutron shape analysis

## Decision Tree (T4.4)

### Nuclide Identification and gamma energy calibration

#### *NUCL\_ID#3: neutron energy spectrum shape analysis*

possibility to disentangle between different neutron sources in several conditions

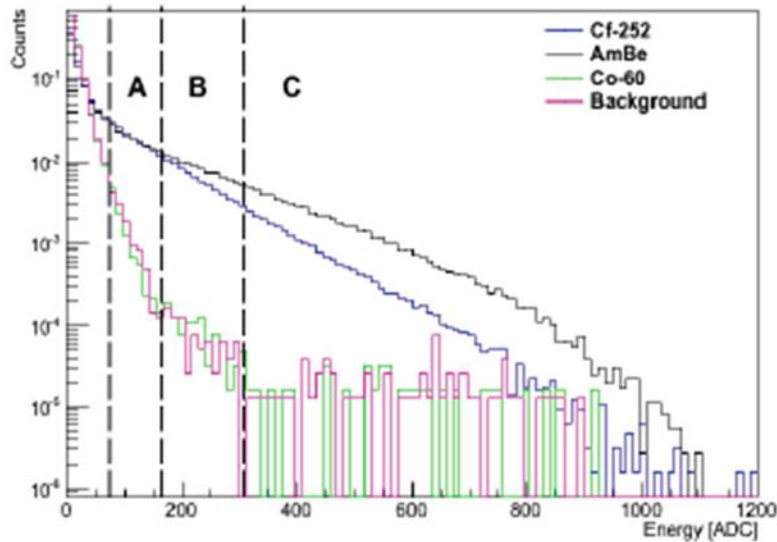

Efficiency Plot for Cf and AmBe

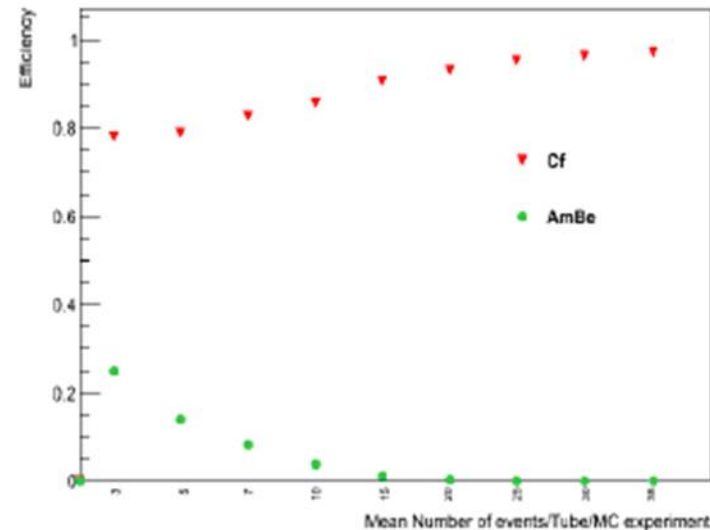

example of  $^{252}\text{Cf}$  – AmBe discrimination test

# Summary

- MODES\_SNM survived all transportations over 15000 km (by sea and land) and end user operation under different conditions: it look very robust!
- The end-users are able to run the system without problems
- No emergency calls from the demo places
- **Taking into account the time that we had for the final integration of the subcomponents the results are more than satisfactory**
- Publications in newspapers and border security magazines
  - Scientific articles are in preparation
- MODES\_SNM system is currently stored in Arktis laboratories
- **What happens next?**
  - **Next round of R&D?**
  - **Towards a commercial product?**

# Back up

---

# Concept of a modular detector system

- Easy transportation
- User friendly
  - Can be used by non-experts
  - Safe operation
- Robust
- Long lived
- Fast, stable and reliable

# MODES\_SNM: Project status

Start: Jan. 2012

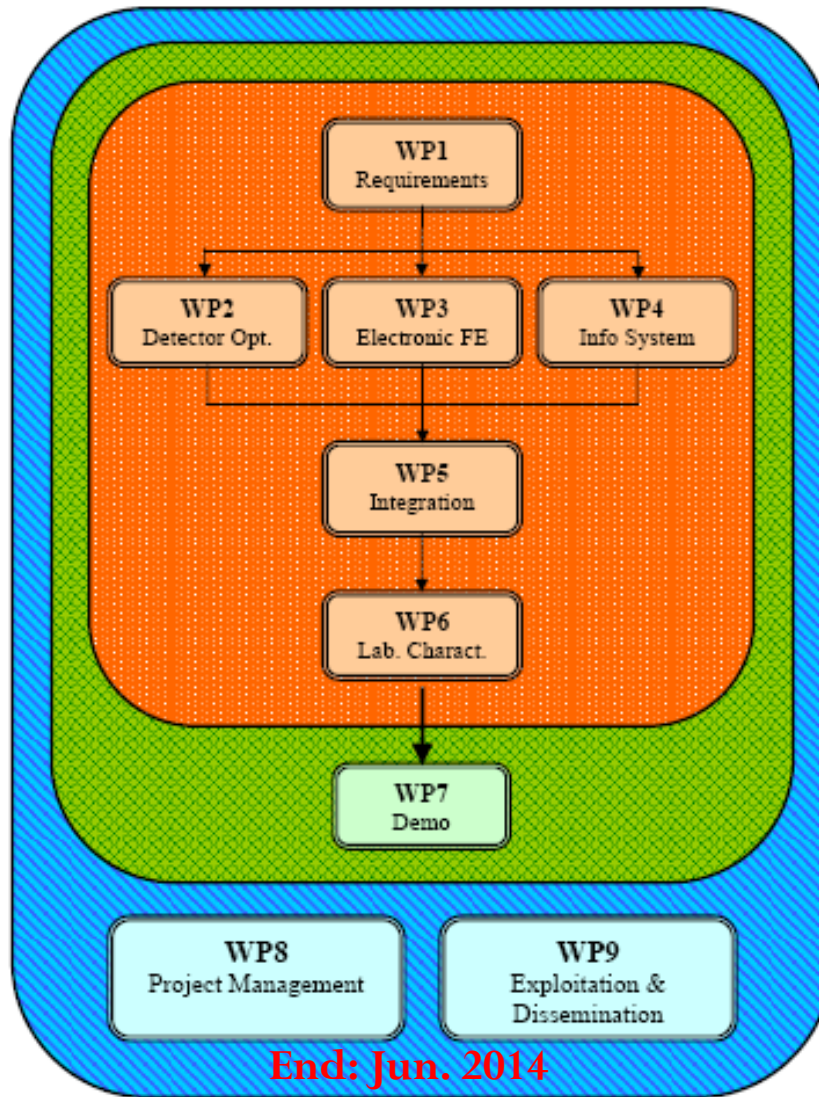

# Xenon as a high pressure photon detector

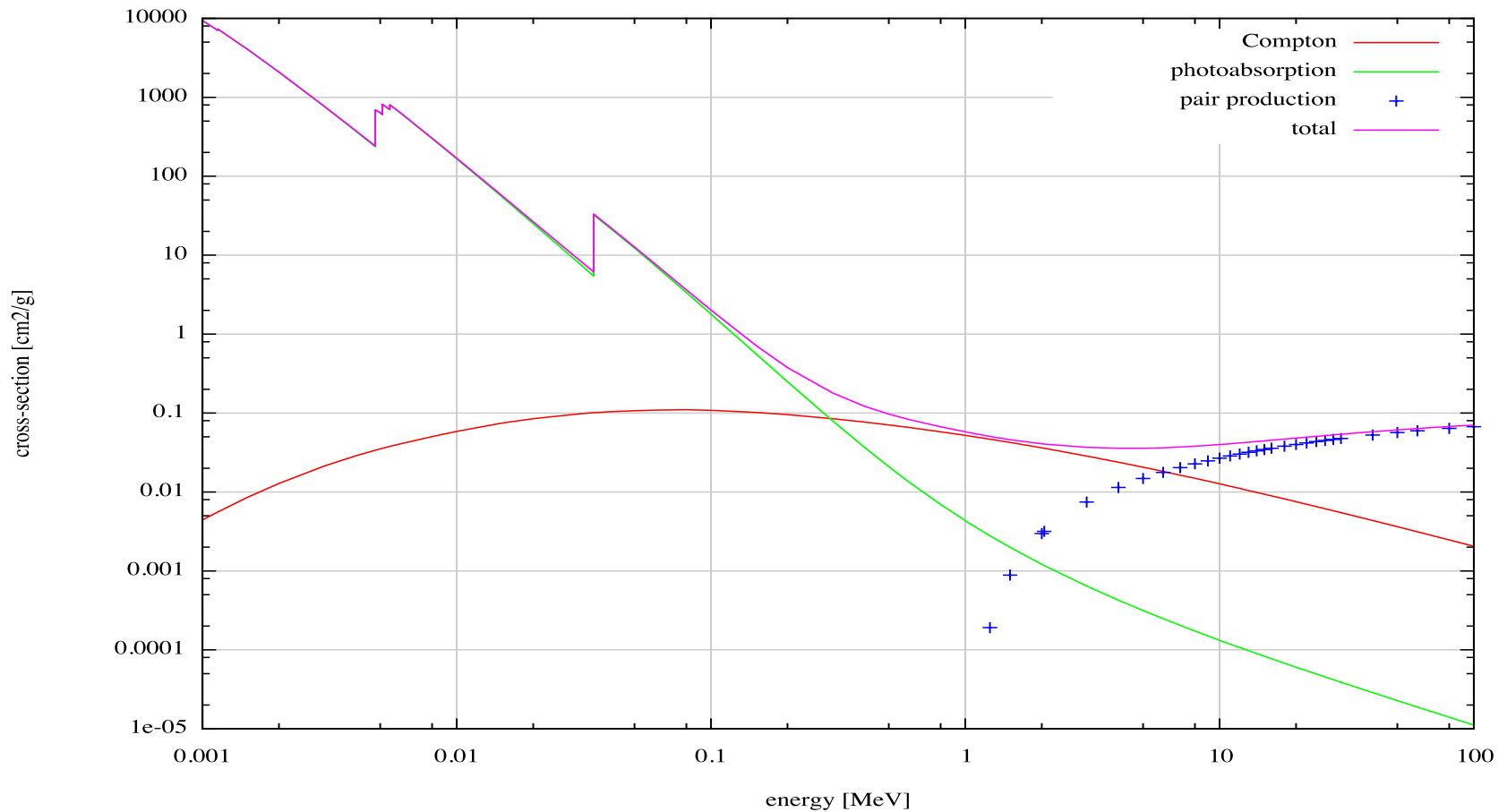



# Isothermal curves for Xe

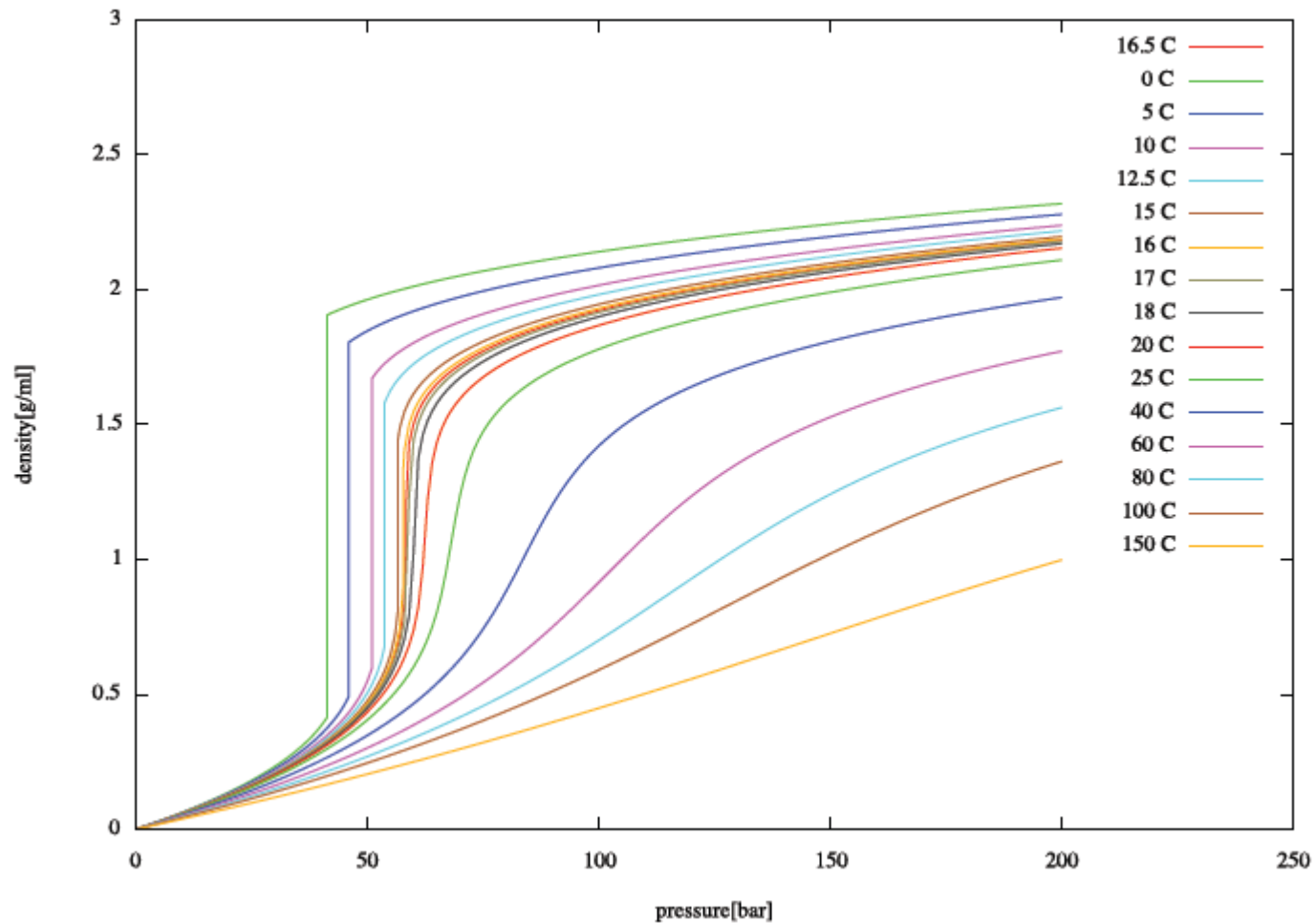

# Isochoric curves for Xe

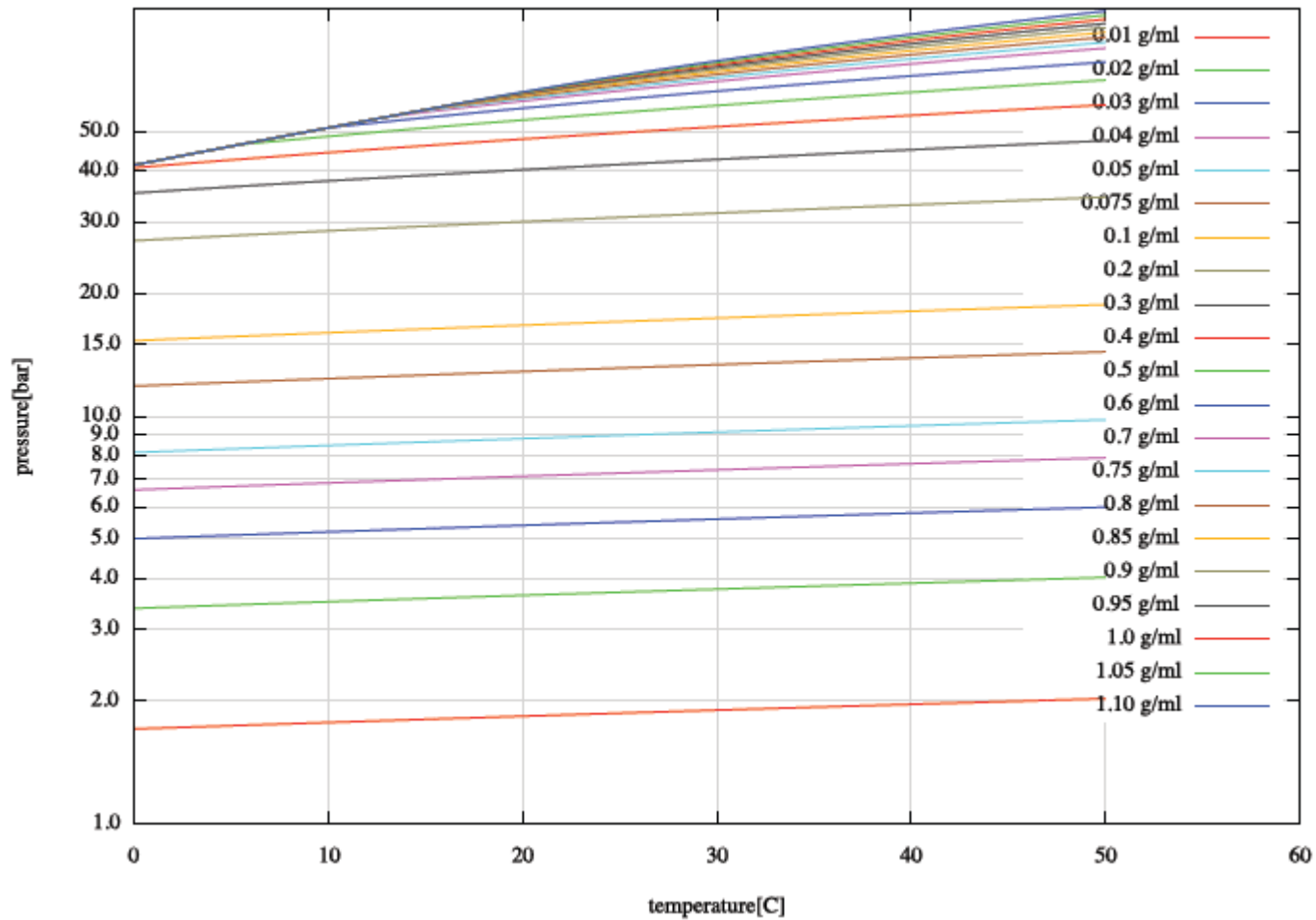

# Neutron-photon discrimination using high pressure He-4 detectors

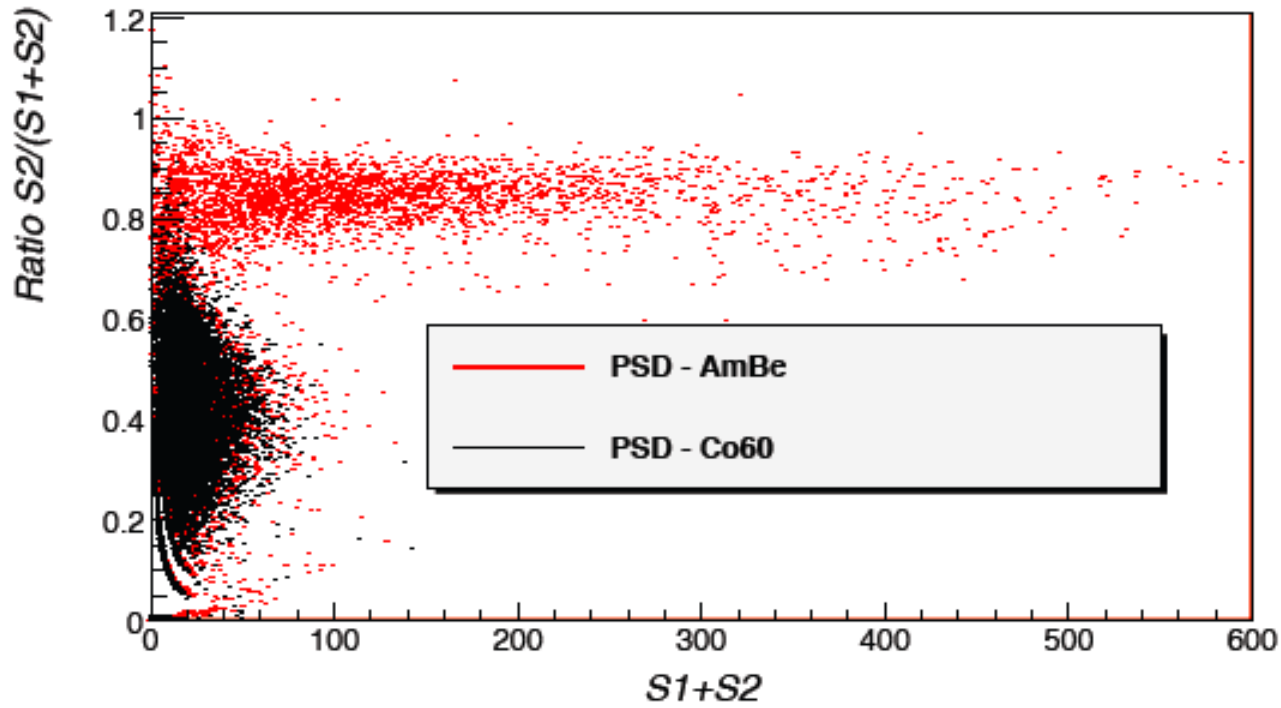

# Neutron detector

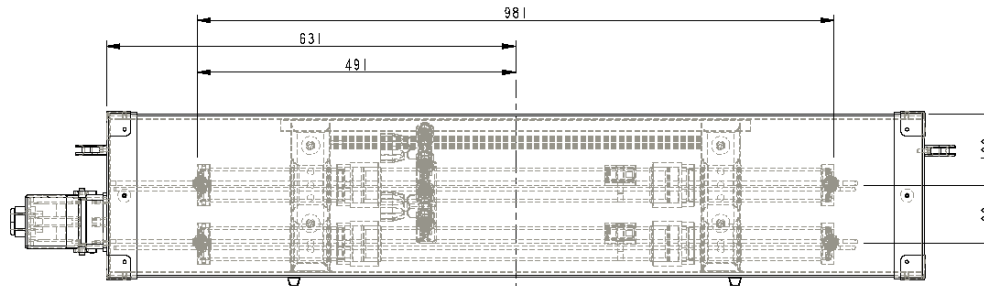
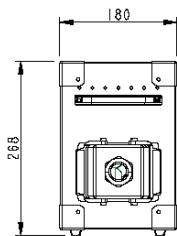
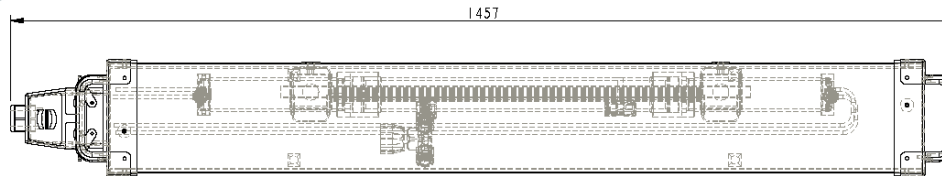
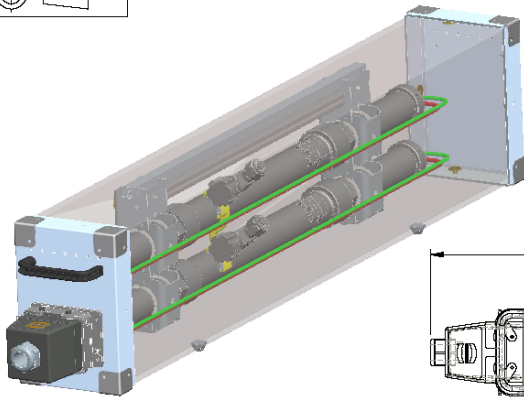
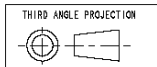

THE UNIVERSITY OF LIVERPOOL  
DEPARTMENT OF PHYSICS

PROJECT MODES

TITLE FAST & SLOW DETECTORS

DRAWING NUMBER NP65-01-15

ARRBT. DRAWING NP65-01-01

ISSUE	DATE	NAME	DESCRIPTION
A	06-Dec-13	J.L. CARROLL	FIRST ISSUE
MODIFICATIONS			

UNLESS OTHERWISE SPECIFIED:- ALL DIMENSIONS IN MILLIMETRES SURFACE TEXTURE VALUES IN MICROMETRES SURFACE TEXTURE TO BE <input checked="" type="checkbox"/> MACHINE ALL OVER OR WHERE MARKED <input checked="" type="checkbox"/>	METRIC SCREW THREADS TO BS8433 CLASS 6H/6g TOLERANCES UNLESS OTHERWISE SPECIFIED MACHINED DIMS: ± ANGULAR ± °	DRAWING PRACTICE AND TOLERANCE INTERPRETATION TO BS308 MATERIAL SPEC TREATMENT FINISH	WELDING SYMBOLS TO BS 499 DRAWN DATE CHECKED APPROVED
REMOVE BURRS AND BREAK SHARP EDGES	DO NOT SCALE	NATURAL	C. TOURANARIS

SHEET 1 OF 1 SHEETS SCALE: 1:4 A2

# Gamma detector

THIRD ANGLE PROJECTION

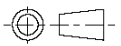
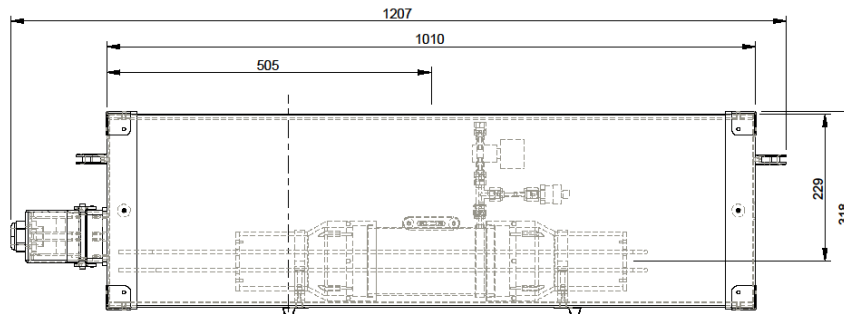
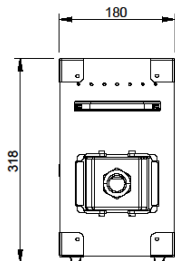
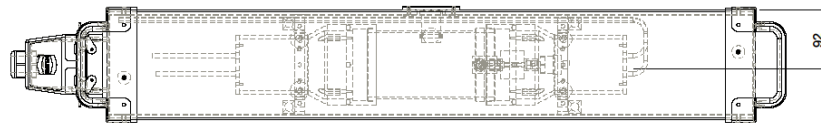
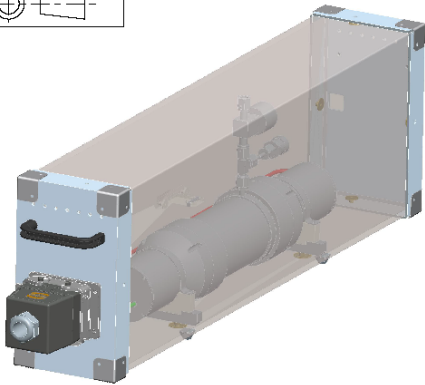



ISSUE	DATE	NAME	DESCRIPTION
A	05-Dec-13	J.L. CARROLL	FIRST ISSUE
MODIFICATIONS			

UNLESS OTHERWISE SPECIFIED:- ALL DIMENSIONS IN MILLIMETRES SURFACE TEXTURE VALUES IN MICROMETRES SURFACE TEXTURE TO BE MACHINE ALL OVER OR WHERE MARKED ✓	TOLERANCES	MATERIAL	DRAWING PRACTICE AND TOLERANCE INTERPRETATION TO BS338	WELDING SYMBOLS TO BS 499
	MACHINED DIMS ±	SPEC	DATE	J.L. CARROLL
	ANGULAR ± °	TREATMENT	CHECKED	05-Dec-13
	REMOVE BURRS AND BREAK SHARP EDGES	DO NOT SCALE	FINISH	NATURAL

THE UNIVERSITY OF LIVERPOOL DEPARTMENT OF PHYSICS	
PROJECT	MODES
TITLE	GAMMA DETECTOR
DRAWING NUMBER	NP65-01-25
ARRGT. DRAWING	NP65-01-01
SHEET 1	OF 1 SHEETS SCALE: 1:4

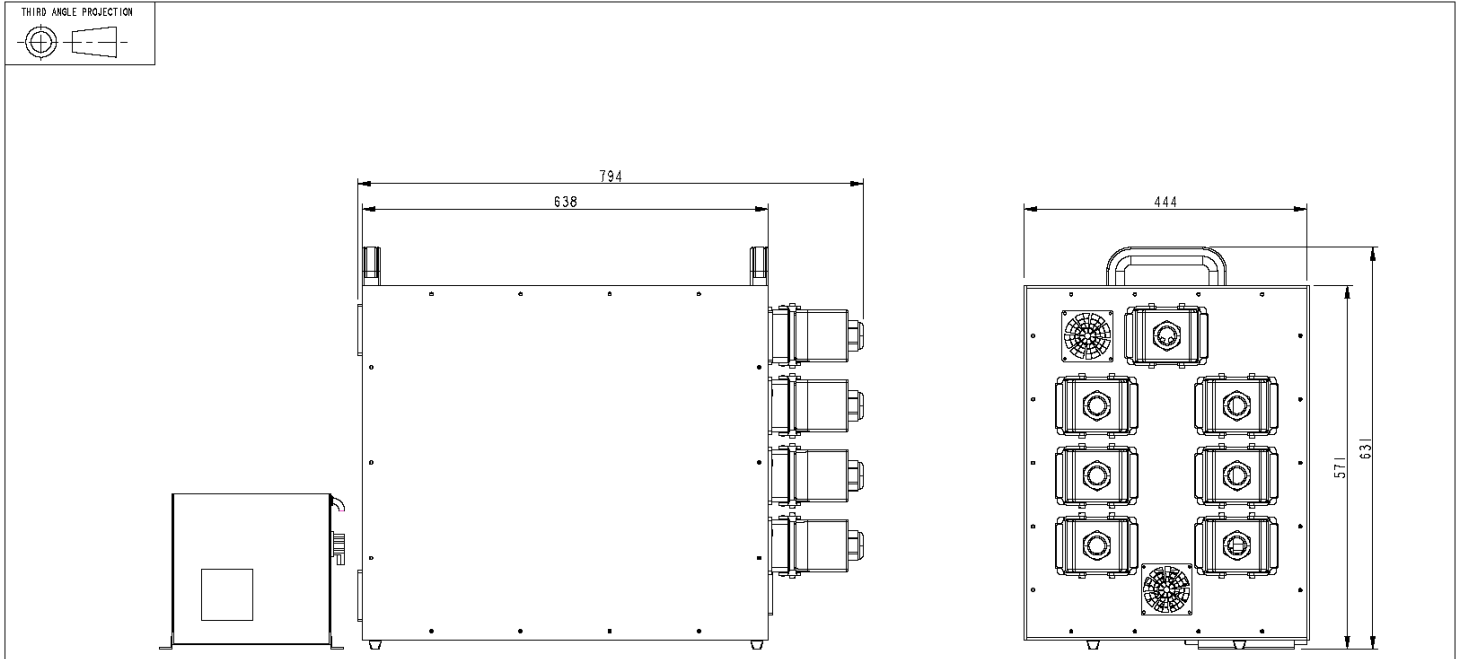
# Electronics and computer box



A	06-Dec-13	J.L. CARROLL	FIRST ISSUE
ISSUE	DATE	NAME	DESCRIPTION
MODIFICATIONS			

UNLESS OTHERWISE SPECIFIED:- ALL DIMENSIONS IN MILLIMETRES SURFACE TEXTURE VALUES IN MICROMETRES SURFACE TEXTURE TO BE <input checked="" type="checkbox"/> MACHINE ALL OVER OR WHERE MARKED <input checked="" type="checkbox"/>	METRIC SCREW THREADS TO BS3443 CLASS 6H/6g TOLERANCES UNLESS OTHERWISE SPECIFIED MACHINED DIMS: ± ANGULAR ± °	DRAWING PRACTICE AND TOLERANCE INTERPRETATION TO BS308 MATERIAL SPEC TREATMENT FINISH	WELDING SYMBOLS TO BS 499 DRAWN DATE CHECKED APPROVED	J. L. CARROLL 06-Dec-13 C. TOURANAKIS	THE UNIVERSITY OF LIVERPOOL DEPARTMENT OF PHYSICS PROJECT TITLE ELECTRONICS BOX & BATTERIES DRAWING NUMBER NP65-01-50 SHEET 1	ABDT. DRAWING NP65-01-01 OF SHEETS SCALE: 1:4 A2
---	--	---	---	---	--	---